

# HP 54503A 500 MHz Digitizing Oscilloscope

## Front-Panel Reference

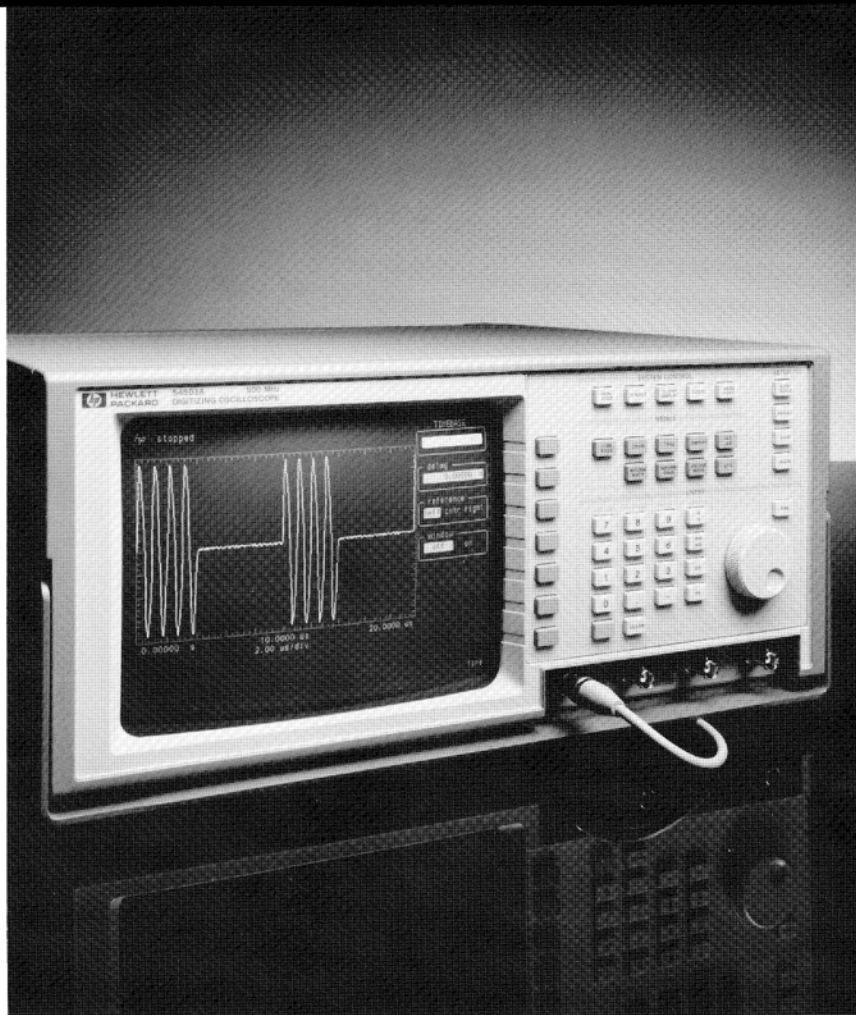

---

 **HEWLETT  
PACKARD**

---

---

# HP 54503A Digitizing Oscilloscope

## Front-Panel Operation

---



Copyright Hewlett-Packard Company 1989

Publication 54503-90901

Printed in the U.S.A. July 1989

## **Herstellerbescheinigung**

Hiermit wird bescheinigt, daß das Gerät/System

HP 54503A

in Übereinstimmung mit den Bestimmungen von Postverfügung 1046/84 funkentstört ist.

Der Deutschen Bundespost wurde das Inverkehrbringen dieses Gerätes/Systems angezeigt und die Berechtigung zur Überprüfung der Serie auf Einhaltung der Bestimmungen eingeräumt.

Zusatzinformation für Meß- und Testgeräte

Werden Meß- und Testgeräte mit ungeschirmten Kabeln und/oder in offenen Meßaufbauten verwendet, so ist vom Betreiber sicherzustellen, daß die Funk-Entstörbestimmungen unter Betriebsbedingungen an seiner Grundstücksgrenze eingehalten werden.

### **Manufacturer's declaration**

This is to certify that this product HP 54503A meets the radio frequency interference requirements of directive 1046/84. The German Bundespost has been notified that this equipment was put into circulation and was granted the right to check the product type for compliance with these requirements.

Additional Information for Test- and Measurement Equipment

Note: If test and measurement equipment is operated with unshielded cables and/or used for measurements on open set-ups, the user must insure that under these operating conditions, the radio frequency interference limits are met at the border of his premises.

---

## **Product Warranty**

This Hewlett-Packard product has a warranty against defects in material and workmanship for a period of three years from date of shipment. During warranty period, Hewlett-Packard Company will, at its option, either repair or replace products that prove to be defective.

For warranty service or repair, this product must be returned to a service facility designated by Hewlett-Packard. However, warranty service for products installed by Hewlett-Packard and certain other products designated by Hewlett-Packard will be performed at the Buyer's facility at no charge within the Hewlett-Packard service travel area. Outside Hewlett-Packard service travel areas, warranty service will be performed at the Buyer's facility only upon Hewlett-Packard's prior agreement and the Buyer shall pay Hewlett-Packard's round trip travel expenses.

For products returned to Hewlett-Packard for warranty service, the Buyer shall prepay shipping charges to Hewlett-Packard and Hewlett-Packard shall pay shipping charges to return the product to the Buyer. However, the Buyer shall pay all shipping charges, duties, and taxes for products returned to Hewlett-Packard from another country.

Hewlett-Packard warrants that its software and firmware designated by Hewlett-Packard for use with an instrument will execute its programming instructions when properly installed on that instrument. Hewlett-Packard does not warrant that the operation of the instrument software, or firmware will be uninterrupted or error free.

## **Limitation of Warranty**

The foregoing warranty shall not apply to defects resulting from improper or inadequate maintenance by the Buyer, Buyer-supplied software or interfacing, unauthorized modification or misuse, operation outside of the environmental specifications for the product, or improper site preparation or maintenance.

**NO OTHER WARRANTY IS EXPRESSED OR IMPLIED.  
HEWLETT-PACKARD SPECIFICALLY DISCLAIMS THE  
IMPLIED WARRANTIES OR MERCHANTABILITY AND FITNESS  
FOR A PARTICULAR PURPOSE.**

**Exclusive Remedies** THE REMEDIES PROVIDED HEREIN ARE THE BUYER'S SOLE AND EXCLUSIVE REMEDIES. HEWLETT-PACKARD SHALL NOT BE LIABLE FOR ANY DIRECT, INDIRECT, SPECIAL INCIDENTAL, OR CONSEQUENTIAL DAMAGES, WHETHER BASED ON CONTRACT, TORT, OR ANY OTHER LEGAL THEORY.

**Assistance** Product maintenance agreements and other customer assistance agreements are available for Hewlett-Packard products.

For any assistance, contact your nearest Hewlett-Packard Sales and Service Office.

**Certification** Hewlett-Packard Company certifies that this product met its published specifications at the time of shipment from the factory. Hewlett-Packard further certifies that its calibration measurements are traceable to the United States National Institute of Standards and Technology, to the extent allowed by the Institute's calibration facility, and to the calibration facilities of other International Standards Organization members.

**Safety** This product has been designed and tested according to International Safety Requirements. To ensure safe operation and to keep the product safe, the information, cautions, and warnings in this manual must be heeded.

# Table of Contents

---

<b>Chapter 1:</b>	1-1	Introduction
-------------------	-----	--------------

---

<b>Chapter 2:</b>		<b>Instrument Setup</b>
	2-1	Introduction
	2-1	Unpacking
	2-1	Contents of Shipment
	2-1	Initial Inspection
	2-2	List of Accessories
	2-2	Operating Environment
	2-2	Storage and Shipping
	2-3	Rear Panel Layout
	2-3	Power Requirements
	2-3	Applying Power
	2-5	Installing the Power Cord
	2-5	Selecting Line Voltage
	2-6	Checking for the Correct Fuse
	2-6	Line Switch
	2-7	Intensity Control
	2-7	Air Flow Requirements
	2-7	Storage and Shipment
	2-8	Connecting External Equipment

---

## Chapter 3:

	<b>Front Panel Overview</b>
3-1	Introduction to the Front Panel
3-2	System Control
3-2	RUN/STOP Key
3-3	SINGLE Key
3-3	CLEAR DISPLAY Key
3-3	LOCAL Key
3-3	HARDCOPY Key
3-4	Setup
3-5	AUTOSCALE Key
3-5	RECALL Key
3-6	SAVE Key
3-6	SHOW Key
3-7	Menus
3-8	Entry
3-8	Numeric Keypad
3-9	Knob
3-9	FINE Key
3-9	Input
3-10	Display
3-11	Instrument Reset

---

## Chapter 4:

	<b>Timebase Menu</b>
4-1	Introduction to the Timebase
4-1	Time/Div Key
4-2	delay Key
4-2	reference Key
4-3	window Key
4-4	timebase Key
4-4	position Key
4-4	Window Exercise
4-4	Setting the Input Signal
4-5	Setting the Oscilloscope
4-5	Viewing the Window

---

## Chapter 5:

	<b>Channel Menu</b>
5-1	Introduction to Channels
5-1	CHANNEL Key
5-2	Vertical Sensitivity Key
5-2	offset Key
5-3	coupling Key
5-3	more Key
5-4	probe Key
5-4	ECL Key
5-5	TTL Key

---

## Chapter 6:

	<b>Trigger Menu</b>
6-1	Introduction to the Triggers
6-1	Trigger Mode Interaction
6-2	Edge Trigger Mode
6-3	Trig'd/auto Key
6-3	source Key
6-3	level Key
6-3	slope Key
6-3	holdoff Key
6-4	Holdoff Exercise
6-4	Instrument Setup
6-4	Oscilloscope Setup
6-8	Pattern Trigger Mode
6-9	pattern Key
6-9	when Key
6-10	holdoff Key
6-10	Pattern Trigger Exercise
6-10	Instrument Setup
6-11	Oscilloscope Setup
6-15	State Trigger Mode
6-15	clock Key
6-15	when Key
6-16	present Key
6-16	holdoff Key
6-16	State Trigger Exercise

6-16	Instrument Setup
6-17	Oscilloscope Setup
6-20	Delay Trigger Mode
6-20	qualify on Key
6-20	edge Qualify Option
6-21	pattern Qualify Option
6-21	state Qualify Option
6-22	delay Key
6-22	trigger on Key
6-23	Delay Trigger Exercise
6-23	Instrument Setup
6-23	Oscilloscope Setup
6-27	TV Trigger Mode
6-27	source Key
6-28	level/polarity Key
6-28	field Key
6-28	line Key
6-28	holdoff Key
6-29	TV Trigger Exercise
6-29	Instrument Setup
6-29	Oscilloscope Setup

---

## Chapter 7:

	<b>Display Menu</b>
7-1	Introduction to the Display
7-2	Display Mode Key
7-2	norm
7-3	avg
7-3	env
7-4	# of screens Key
7-5	off/frame/ axes/grid Key
7-6	connect dots Key

---

**Chapter 8:**

	<b>Delta t/Delta V Menu</b>
8-1	Introduction to the Markers
8-2	$\Delta V$ markers
8-2	Vmarker 2
8-2	Vmarker 1
8-3	$\Delta t$ markers
8-3	start marker
8-3	stop marker

---

**Chapter 9:**

	<b>Waveform Math Menu</b>
9-1	Introduction to the Functions
9-2	Defining a Function
9-2	Function Key
9-2	display Key
9-3	chan/mem Key
9-3	Operator Key
9-4	chan/mem Key
9-4	sensitivity Key
9-4	offset Key
9-4	Vertical Scaling Units
9-4	Displaying Functions
9-7	Waveform Math Exercise
9-7	Instrument Setup
9-7	Oscilloscope Setup

---

## **Chapter 10:**

	<b>Waveform Save Menu</b>
10-1	Introduction to the Memories
10-1	waveform/pixel Key
10-2	waveform Menu
10-2	nonvolatile Key
10-2	display Key
10-2	source Key
10-2	store Key
10-3	pixel Menu
10-3	volatile Key
10-3	display Key
10-3	clear memory Key
10-3	add to memory Key
10-4	Waveform Save Exercise
10-4	Instrument Setup
10-4	Oscilloscope Setup

---

## **Chapter 11:**

	<b>Define Measure Menu</b>
11-1	Introduction to Measurements
11-2	Measurement Selection
11-3	meas/meas def/meas limit Key
11-3	meas Sub-menu
11-3	continuous Key
11-3	statistics Key
11-4	Measure Define Sub-menu
11-4	standard/user defined Key
11-4	thresholds/measurements Key
11-7	Measure Limit Sub-menu
11-7	test Key
11-8	set Key
11-8	fail if Key
11-8	or if Key
11-8	save to Key
11-8	after save Key

---

## Chapter 12:

	<b>Utility Menu</b>
12-1	Introduction to the Utilities
12-2	HP-IB menu
12-2	talk only mode
12-2	addressed mode
12-3	EOI Key
12-3	form feed Key
12-3	paper length Key
12-3	exit menu Key
12-4	selftest menu
12-5	ram Test
12-5	rom Test
12-6	acquisition Test
12-6	Miscellaneous Test
12-6	loop Test
12-6	start test Key
12-6	exit menu Key
12-7	probe cal menu
12-8	attenuation submenu
12-8	channel Key
12-8	start cal Key
12-8	continue Key
12-8	abort Key
12-8	exit menu Key
12-9	time null submenu
12-9	channel Key
12-9	time Key
12-9	exit menu Key
12-10	Self Cal menu
12-10	cal select Key
12-10	channel Key
12-10	start cal Key
12-11	continue Key
12-11	abort Key
12-11	exit menu Key
12-11	service menu
12-11	clicker Key
12-12	Calibration Procedure

---

## Appendix A:

	<b>Algorithms</b>
A-1	Measurement Setup
A-1	Making Measurements
A-2	Automatic Top-Base
A-3	Edge Definition
A-3	Algorithm Definitions
A-3	delay
A-4	+ width
A-5	- width
A-5	Period
A-5	Frequency
A-5	Duty Cycle
A-5	Risetime
A-5	Falltime
A-5	$V_{max}$
A-5	$V_{min}$
A-5	$V_{p-p}$
A-6	$V_{top}$
A-6	$V_{base}$
A-6	$V_{amp}$
A-6	$V_{avg}$
A-6	$V_{rms}$

---

## Appendix B:

## Specifications and Characteristics



# Introducing the HP 54503A

1

## Introduction

The HP 54503A Digitizing Oscilloscope is a general purpose, 500 MHz bandwidth oscilloscope. The HP 54503A has four channels with full sensitivity. Full HP-IB programmability has been incorporated into the HP 54503A for use in a broad range of HP-IB applications, from high-speed ATE to device characterization in research and development applications.

The HP 54503A features an easy-to-use human interface, yet has many sophisticated capabilities and multiple triggering functions. Waveforms are easily stored for future reference, waveform measurements are automatic, and instant hardcopy can be made when the HP 54503A is teamed with an HP-IB compatible printer or HP-GL plotter.

Some of the key features of the HP 54503A 500 MHz Digitizing Oscilloscope are listed below. A complete list of specifications and operating characteristics are listed in appendix B of this manual.

- Repetitive bandwidth - dc to 500 MHz
- Single shot bandwidth - 2 MHz (2 channels, simultaneous)
- Sample rate - 20 Megasamples/second
- Four channel input and display
- Maximum vertical sensitivity - 1 mV/division
- Minimum vertical sensitivity - 5 V/division
- Vertical resolution (A/D) - 8 bits
- Autoscale for automatic setup
- Automatic measurements, with user definition and statistics
- Hardcopy output
- Measurement limit test
- Waveform math ( + , - , x , vs , invert , only)
- Waveform Record Length - 1024 points (HP-IB) 501 points (display)
- Four nonvolatile set-up memories

- Four nonvolatile waveform memories
- Two volatile pixel memories
- Dual timebase windowing
- Advanced logic triggering (including 1.5 ns glitch trigger)
- TV triggering
- Pre- and post-trigger viewing capability
- ECL/TTL presets

**2 - Instrument Setup**

---

## Introduction

This chapter contains information for unpacking, applying power, and connecting optional accessories to the HP 54503A. Inspection, power requirements, and instruction for running the HP 54503A selftest for performance verification are also included in this chapter.

---

## Initial Inspection

Inspect the shipping container for damage. If the shipping container or cushioning material is damaged, keep it until the contents of the shipment have been checked. Check the shipment for completeness and the instrument electrically and mechanically.

If the contents are incomplete, there is mechanical damage or defect, or if the instrument does not pass the selftest performance verification, notify the nearest Hewlett-Packard Office. Keep the shipping materials for carrier's inspection. The Hewlett-Packard Office will arrange for repair or replacement at HP option without waiting for claim settlement.

## Contents of Shipment

The following items are shipped with the HP 54503A Digitizing Oscilloscope:

- Two HP 10430A Probes
- Probe to BNC Adapter, 1250-1454
- One Power Cord
- *HP 54503A Getting Started Guide*
- *HP 54503A Front-Panel Reference*
- *HP 54503A Programming Reference*
- *HP 54503A Service Manual*
- *Feeling Comfortable with Digitizing Oscilloscopes (A Guide to Technology)*

**Available Accessories** The following optional accessories are available for use with the HP 54503A:

- Carrying Case, HP Part Number 1540-1066
- Rack Mount Kit, HP Part Number 5061-6175
- HP 10100C 50  $\Omega$  Feedthrough Terminator
- HP 1133A TV/Video Sync Pod
- HP 10024A Integrated Circuit 16-pin Test Clip
- HP 10211A Integrated Circuit 24-pin Test Clip
- PC Board Horizontal Mini Probe Socket, HP Part Number 1250-1737
- PC Board Vertical Mini Probe Socket, HP Part Number 1250-1918
- HP 10437A 1:1 Probe
- HP 10438A 1:1 Probe (1 meter)
- HP 10439A 1:1 Probe (2 meter)
- HP 10002A 50:1 1 M $\Omega$  (1000V peak) Probe
- HP 1137A High Voltage 1000:1 Divider Probe
- HP 10200A Resistive Divider Probe Kit
- BNC to Miniature Probe Adapter, HP Part Number 1250-1454
- HP 10240B BNC Blocking Capacitor
- HP 11094B 75 $\Omega$  Feedthrough Termination
- HP 5061-6183 Front Panel Cover

---

## Operating Environment

The HP 54503A oscilloscope is operated in a normal lab or bench environment without any additional considerations. Note the non-condensing humidity limitation in the list of characteristics supplied in this manual. Condensation in the instrument cabinet can cause poor operation or malfunction. Protection should be provided against temperature extremes which cause condensation.

## Storage and Shipping

The HP 54503A may be stored or shipped in environments with the following limitations:

- Temperature: -40° C to +75° C
- Humidity: Up to 90% at 65° C
- Altitude: Up to 15,300 meters (50,000 feet)

If the HP 54503A is to be shipped to a Hewlett-Packard Service Center for service or repair, attach a tag to the instrument identifying owner, address of owner, complete instrument model number and serial number and a description of required service.

If the original packaging material is no longer available, identical packing material is available through local Hewlett-Packard offices. Mark the container FRAGILE to ensure careful handling. In any correspondence, refer to the instrument by the model and serial number.

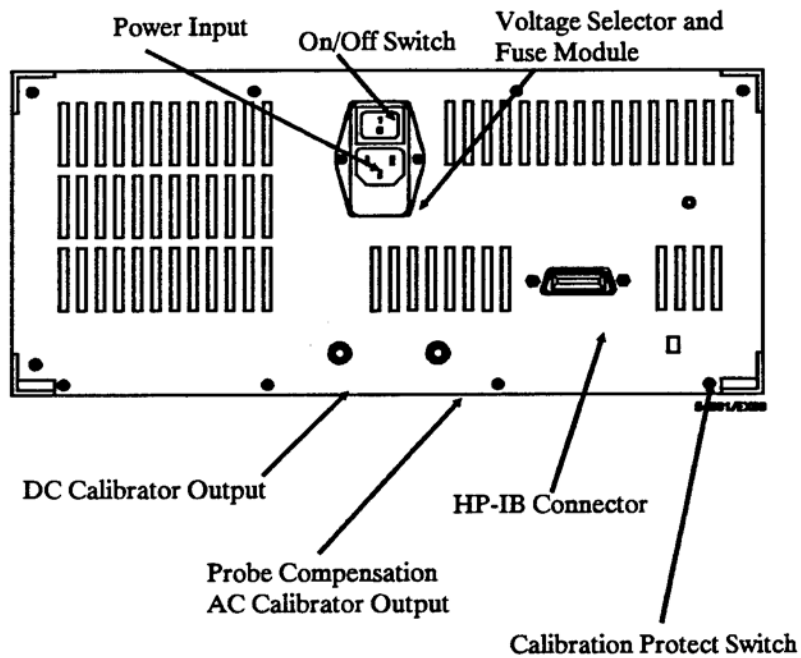

*Figure 2-1. HP 54503A Rear Panel*

---

## Rear Panel

The rear panel of the HP 54503A contains the power input, voltage selector module, power switch, external connectors, and calibrator protection switches as shown in figure 2-1.

**Power Requirements** The HP 54503A requires a power source of either 115 or 230 Vac, -22% to +10%; single phase, 48 to 66 Hz; 200 Watts maximum power.

**Selecting Line Voltage** The fuse module has been set at the factory to the line voltage used in the country of destination. Check the setting of the fuse module to verify it is in the correct position for the voltage to be used. If the setting needs to be changed, use the following procedure.

### CAUTION

*BEFORE APPLYING POWER TO THE INSTRUMENT, BE SURE THE FUSE MODULE IS SET TO THE CORRECT LINE VOLTAGE POSITION. Severe damage will occur if the line voltage is not properly set.*

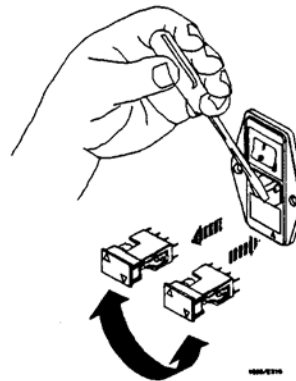
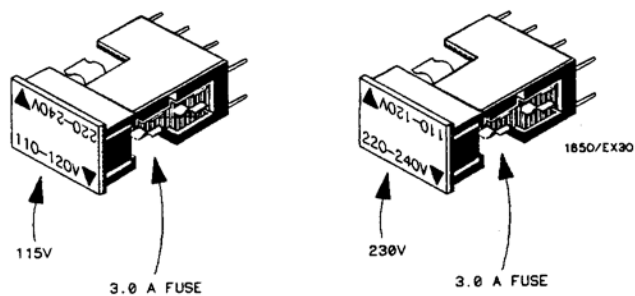

Figure 2-2. Selecting Line Voltage

Change the fuse module position by pulling the fuse module out and reinserting it with the appropriate arrows aligned.







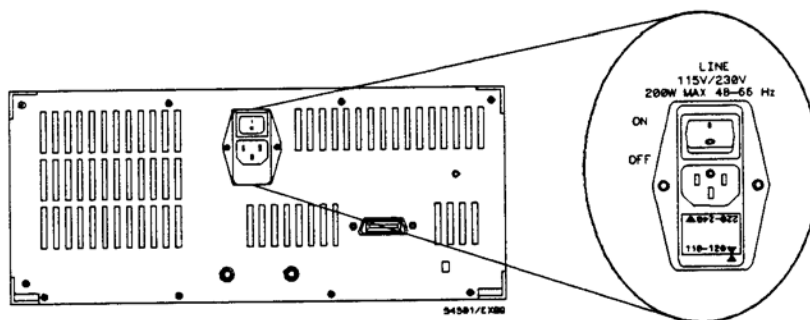





*Figure 2-3. Checking for the Correct Fuse*

- Carefully pry at the top center of the module as shown, until it can be grasped and pulled out.



*Figure 2-4. Line Switch*

PLUG TYPE	CABLE PART NO.	PLUG DESCRIPTION	LENGTH IN/CM	COLOR	COUNTRY
OPT 900  250V	812D-1351 812D-1703	Straight *BS1363A 90°	90/228 90/228	Gray Mint Gray	United Kingdom, Cyprus, Nigeria, Zimbabwe, Singapore
OPT 901  250V	812D-1369 812D-0696	Straight *NZS190/ASC 90°	79/200 87/221	Gray Mint Gray	Australia New Zealand
OPT 902  250V	812D-1689 812D-1692 812D-2857	Straight *CEE7-Y11 90° Straight (Shielded)	79/200 79/200 79/200	Mint Gray Mint Gray Coco Brown	East and West Europe, Saudi Arabia, So. Africa, India (Unpolarized in many nations)
OPT 903**  125V	812D-1376 812D-1521 812D-1992	Straight *NEMA5-15P 90° Straight (Medical) UL544	90/228 90/228 96/244	Jade Gray Jade Gray Black	United States, Canada, Mexico, Philippines, Taiwan
OPT 904**  250V	812D-0698	Straight *NEMA6-15P	80/228	Black	United States, Canada
OPT 905  250V	812D-1396 812D-1625	CEE22-V1 (System Cabinet Use) 250V	30/76 96/244	Jade Gray	For interconnecting system components and peripherals. United States and Canada only
OPT 906  250V	812D-2104 812D-2296	Straight *SEV1011 1959-24507 Type 12 90°	79/200 79/200	Mint Gray Mint Gray	Switzerland
OPT 912  220V	812D-2956 812D-2957	Straight *DHCK107 90°	79/200 79/200	Mint Gray Mint Gray	Denmark
OPT 917  250V	812D-4211 812D-4600	Straight SABS164 90°	79/200 79/200	Jade Gray	Republic of South Africa India
OPT 918  100V	812D-4753 812D-4754	Straight Miti 90°	90/230 90/230	Dark Gray	Japan

Rev. 1/19/94

AR100018

\*Part number shown for plug is industry identifier for plug only. Number shown for cable is HP part number for complete cable including plug.

\*\*These cords are included in the CSA certification approval of the equipment.

E=Earth Ground

L=Line

N=Neutral

Figure 2-5. Available Power Cords

**Verifying the Fuse** If it is necessary to check or change fuses, remove the fuse module and look at each fuse for its amperage and voltage ratings.

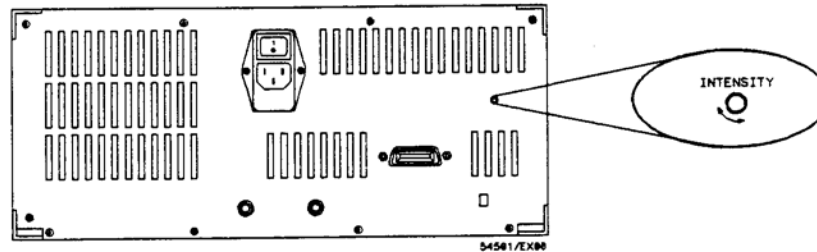

*Figure 2-6. Intensity Control*

**Power Cord** The HP 54503A is a Safety Class 1 instrument with an exposed chassis that is directly connected to earth via the power supply cord to meet IEC Standard 348. This instrument is provided with a three-wire power cable. When connected to an appropriate AC power outlet, this cable grounds the instrument cabinet. The type of power cable plug shipped depends on the country of destination. See figure 2-5 for available power cords.

**Line Switch** The line switch is located on the rear panel. Turn on the oscilloscope by pressing 1 on the rocker switch. The rocker switch is labelled 1 and 0, corresponding to on and off.

**Intensity Control** Once the oscilloscope has been turned on, the display intensity can be adjusted, if necessary. The intensity is adjusted with the Display Intensity control on the rear panel.

**Air Flow Requirements** The HP 54503A must have an unrestricted airflow for the fan and ventilation openings in the rear panel. The HP 54503A may be stacked under, over, or between other instruments provided the other instruments are adequately cooled.

---

## Connecting External Equipment

The HP 54503A is equipped with an HP-IB connector on the rear panel. This is a direct connection to an HP-IB compatible printer, plotter, or external controller.

Connect an HP-IB cable to the oscilloscope and any HP-IB compatible device. Tighten the HP-IB cable with the captive screws of the cable to eliminate the potential of an inadvertent disconnection.

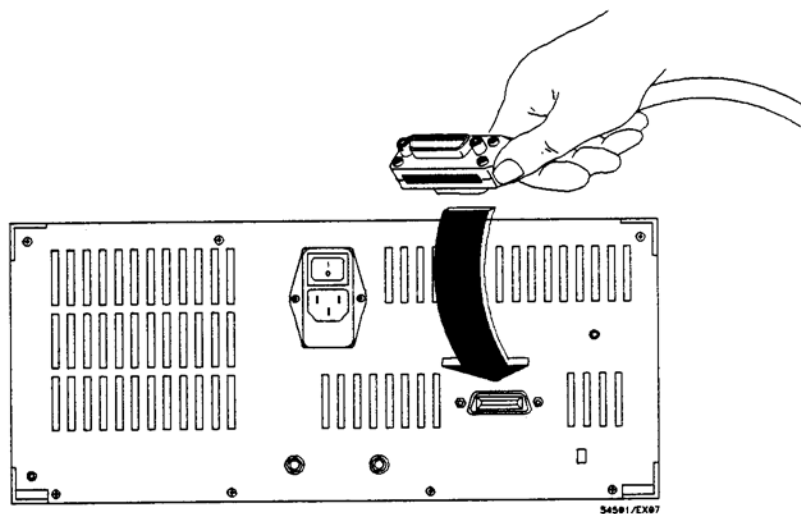

*Figure 2-7. Connecting External Equipment*

The HP 54503A must be properly addressed to communicate with the connected device. The HP 54503A HP-IB address is set in the HP-IB submenu. See Chapter 12 for detailed information about the HP-IB submenu.

**3 - Front Panel Overview**

## Introduction to the Front Panel

This chapter describes the functional sections of the HP 54503A front panel. The explanation of each area also contains their interaction with each other and provide a basis for applications and usages.

The HP 54503A front panel is separated into six functional areas.

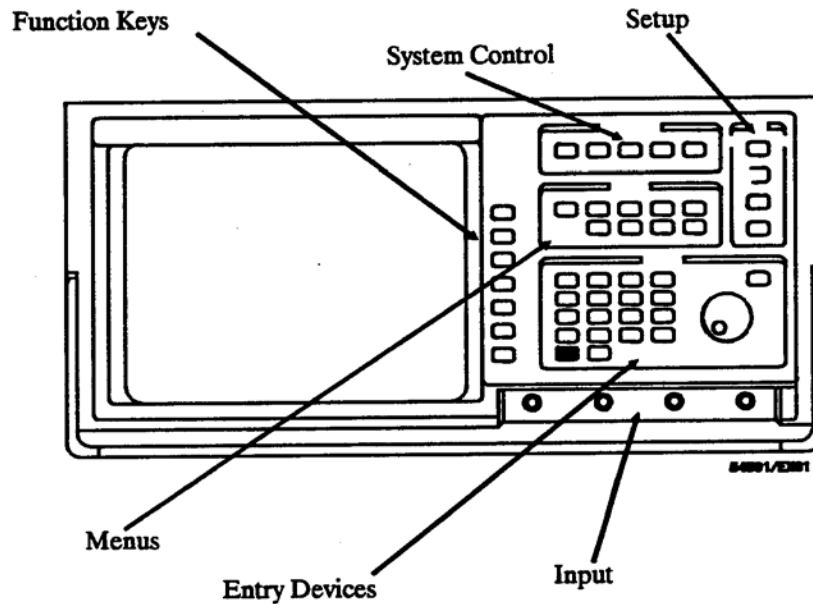
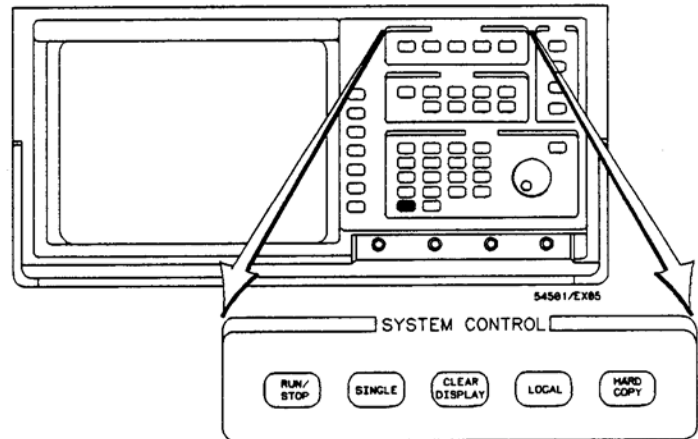

Figure 3-1. HP 54503A Front Panel

## System Control

The SYSTEM CONTROL keys are located along the top of the oscilloscope to the right of the CRT. This section controls the following functions:

- Dynamic display features
- Selecting local control
- Activating hardcopy



*Figure 3-2. System Control Section*

Selection of any key in the SYSTEM CONTROL section causes the oscilloscope to execute that command immediately.

**RUN/STOP Key** The RUN/STOP key toggles the acquisition status of the HP 54503A. If the oscilloscope is currently running (current status is displayed in the top left corner of the CRT in the message field) the instrument is placed in the **stopped** mode. In this mode, normal acquisition is stopped and the last acquired data is displayed. If the oscilloscope is stopped, it is immediately changed to another mode (**running awaiting trigger, auto-trigger, etc**).

**SINGLE Key** The SINGLE key activates the acquisition system for one trigger event. One acquisition is made, displayed and then the data acquisition and display cycle is stopped. This single acquisition is superimposed on the current displayed data. If the display has been cleared before the SINGLE key is pressed, only one acquisition is displayed.

**CLEAR DISPLAY Key** The CLEAR DISPLAY key clears the display and resets all associated measurements. If the oscilloscope is in the stopped mode, all data that is currently displayed is be erased. If the oscilloscope is **running**, all data is erased, however, new data is displayed on the next acquisition. The RUN/STOP and SINGLE keys are not affected.

The RUN/STOP, SINGLE, and CLEAR DISPLAY keys have a relationship that make it possible to manipulate data acquisitions and view one, two, or several acquisitions. It is possible to stop acquiring, clear the display and capture one acquisition for evaluation. The display can be cleared while acquiring to capture new data. When acquisitions are manipulated with these three keys other keys and settings are not affected.

**LOCAL Key** The LOCAL key sends a return to local control message to the HP-IB interface and returns control to the front panel. This key can be locked out if a local lockout command is executed over the HP-IB.

This is the only active front panel key while the oscilloscope is in remote operation, if it has not been locked out.

**HARDCOPY Key** The HARDCOPY key executes an immediate hardcopy of the currently displayed data on a compatible graphics printer or plotter and stops all other oscilloscope functions while the hardcopy is in progress.

The oscilloscope must be in talk only, and the printer must be in listen always. Setup of the hardcopy options are accessed in the HP-IB submenu (see Chapter 12, "Utility Menu.").

Selection of any key will abort the hardcopy action.

## Setup

The **SETUP** section of the front panel controls subsystems for proper display of input data. This section controls display information:

- **AUTOSCALE** for automatic scaling of the waveform display area
- **SAVE** and **RECALL** setups
- Quick access to channel, function, and trigger information on the **SHOW** screen.

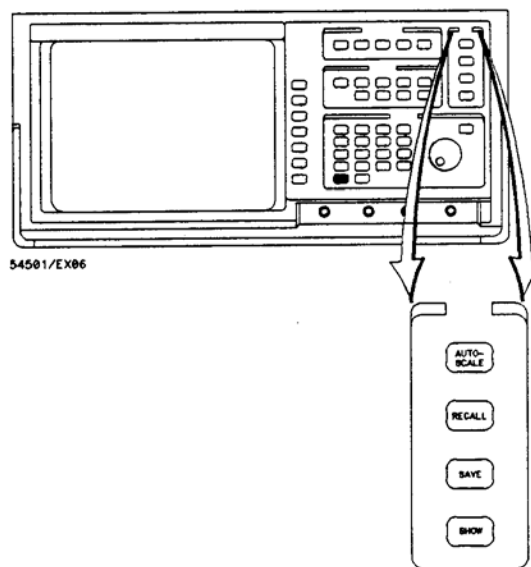

*Figure 3-3. Setup Section*

**AUTOSCALE Key** This key causes the oscilloscope to evaluate all input signals and set the correct conditions to display the signals. When AUTOSCALE is pressed the following conditions are set:

- Vertical sensitivity on all channels
- Vertical offset on all channels
- Sets trigger to edge mode with minimum persistence, holdoff, positive slope, and proper trigger level for the trigger source
- Sets time base for approximately 1 full period of the input signal

In addition, AUTOSCALE includes a soft reset:

- Sets oscilloscope to auto trigger mode of acquisition
- Displays the correct number of screens
- Turns  $\Delta t/\Delta V$  markers off
- Turns all measurements off
- Turns measurement limit test off
- Turns waveform math functions off
- Turns timebase window off
- Turns waveform/pixel memory display off
- Turns measurement limit test off
- Turns connect-the-dots off
- Displays SHOW menu

The previous oscilloscope settings are stored in volatile memory RECALL 0. To recall settings, press RECALL 0.

**RECALL Key** The RECALL key has three primary functions:

- By pressing the RECALL key and then selecting 1, 2, 3, or 4, the HP 54503A executes a recall of a previously saved setup configuration.
- The oscilloscope automatically saves the current configuration before executing an autoscale, recall, or setting up ECL/TTL presets. RECALL 0 is an undo of these actions. You cannot save to RECALL 0.

- **RECALL CLEAR** executes an instrument reset and returns the HP 54503A to default/power-up settings. The oscilloscope does not perform power-up self-tests (see Instrument Reset, in this chapter).

**SAVE Key** The SAVE key immediately stores the oscilloscope setup configuration in volatile memory. Press SAVE, and then select a save register: 1, 2, 3, or 4. An advisory is displayed above the waveform display area indicating the setup configuration has been saved.

**SHOW Key** The SHOW key displays the following information:

1 2.00 V/div  
offset: 50.00 mV

4 40.0 V/div  
offset: -1.000 V

f2 1 + 1  
4.00 V/div  
offset: 100.0 mV

1 50.00 mV  
54501/WF 18

- Channel scaling
- Channel offset
- Channel coupling
- Probe attenuation
- Math function operation
- Math function scaling
- Math function offset
- Memories
- Trigger source
- Trigger level

The SHOW key toggles between the currently selected menu and the SHOW screen (as illustrated).

This screen presents the most complete and detailed instrument setup information. Select this screen before making a hardcopy and all SHOW screen information is included on the hardcopy.

## Menus

The MENUS section consists of nine keys:

- TIMEBASE
- CHANNEL
- TRIG
- DISPLAY
- $\Delta t/\Delta V$
- WFORM MATH
- WFORM SAVE
- DEFINE MEAS
- UTIL

Each of these menus is discussed in the following chapters.

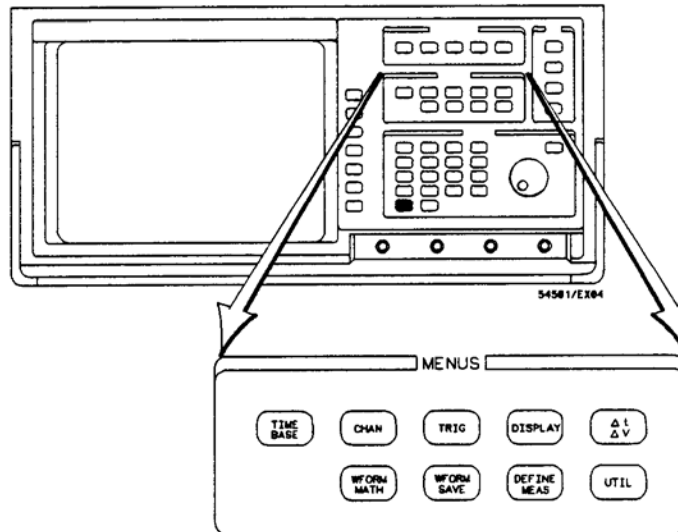

Figure 3-4. MENUS Section

## Entry

The ENTRY devices are a multi-function numeric keypad, a selection knob, and a FINE key.

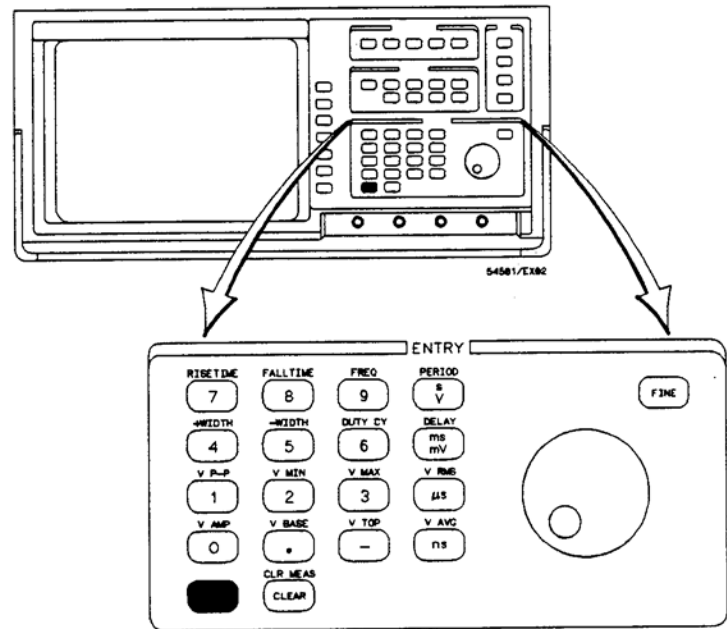

Figure 3-5. ENTRY Section

### Numeric Keypad

The keys on the numeric keypad are for direct numeric input. To input known values directly, press the associated softkey to activate the desired field on screen, and then select the units with the numeric keys. For example, to set the vertical sensitivity to 500 mV:

- Ensure V/div in the Channel menu is the active field (displayed in fullbright)
- Press 5, 0, 0, mv on the numeric keypad.

The blue key on the numeric keypad selects the alternate function when pressed before the key. The CLEAR key clears any selections made for the active field.

**Knob** The knob changes values within each function. It increments, decrements, or toggles the selection in the active field or function. The current selection displayed in full-bright in the displayed menu area can be changed with the knob.

**FINE Key** The FINE key changes the increment and decrement sequence. Instead of sequencing in the normal sequence, the values increment/decrement in more precise values. Use this feature when the normal sequence is too coarse for precision measurements or settings.

When the HP 54503A is operating in the fine mode, the word **fine** is displayed in the lower right corner of the CRT.

---

## Input

The input section consists of connectors for signal input. All inputs have a nominal 1 M $\Omega$  input impedance shunted by approximately 7 pF at the input BNC and a maximum tolerance of 250 V.

Channels 1 through 4 are full-range channels. Use channels 1 and 2 or 3 and 4 if continuous dual channel acquisition.

## Display

The display section contains the screen and menu softkeys.

The vertical column on the right side of the screen is the function display. The functions that are displayed at any one time correspond to a key in the function key column. These keys select any function or field that is displayed in half-bright.

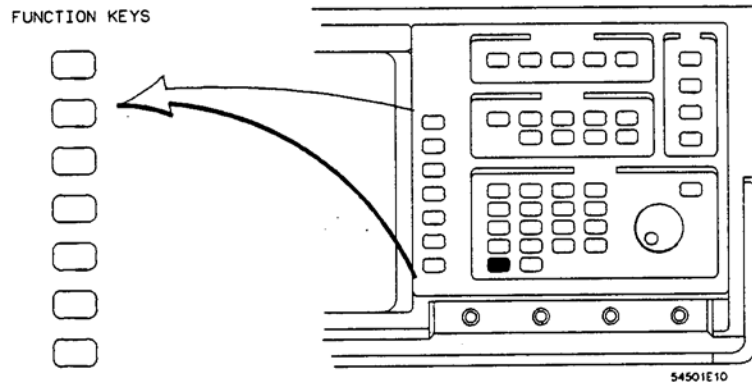

*Figure 3-6. Function Keys*

- Numeric key fields displayed in full-bright are changed by either numeric keys on the keypad or the knob. When these functions are not active, they are displayed in half-bright; when displayed in full-bright they are active.
- Non-numeric fields displayed in half-bright toggle with the corresponding function key. These fields are displayed in half-bright, but are active for the function keys.

---

## Instrument Reset

The HP 54503A has two methods of instrument reset.

- Key-down power up is a hard reset of the oscilloscope. It is done by pressing and holding any front panel key while cycling power. If input signals are not present, the oscilloscope will power-up displaying a baseline in the SHOW screen and set to all default settings (see Table 3-1).
- RECALL CLEAR performs a soft reset of the oscilloscope. All default conditions are set (see Table 3-1). RECALL CLEAR is the same as a key-down power-up except that the previous menu selections are retained.

*Table 3-1. Reset Default Conditions*

Timebase Menu	
reference	cntr
Time/Div	100 $\mu$ s
delay	0.00 s
timebase window	off
Channel Menu	
Channel 1	on
Channel 2-4	off
Volts/Div	500 mV
offset	0.00
coupling	dc
probe attenuation	1.000:1

Table 3-1. Reset Default Conditions (continued)

Trigger Menu	
Mode	edge
source	Channel 1
level	0.0 V
slope	positive
holdoff	40 ns
Display Menu	
Mode	norm
persistence	minimum
# of screens	1
off/frame/axes/grid	axes
connect dots	off
$\Delta t/\Delta V$ Menu	
$\Delta t$ markers	off
$\Delta V$ markers	off
Waveform Math Menu	
f1	off
f2	off
chan/mem	chan 1
operator	+
chan/mem	chan 1
function sensitivity	1.00 V/div
function offset	0.0 V
Waveform Save Menu	
waveform/pixel	waveform
nonvolatile	m1
display	off
source	chan 1
Define Meas Menu	
meas/def/limit	meas
continuous	on



## Introduction to the Timebase

This chapter contains a description of the TIMEBASE menu and how the entire horizontal display and parameters are controlled with this menu.

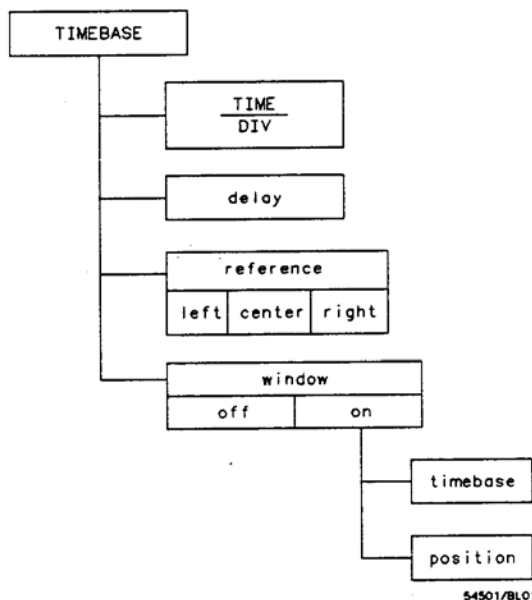
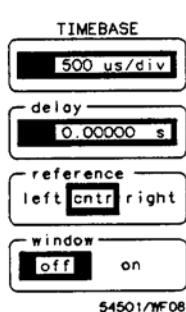

Figure 4-1. Timebase Menu

## Time/Div Key

The time/division function controls the sweep speed on the horizontal axis from 200 ps/div to 5 sec/div. The main timebase is incremented and decremented in a 1-2-5 sequence. The FINE key does not affect the timebase settings.

During slow sweep speeds (200 ms/div to 5 sec/div) the acquisition and write cycle changes. At these sweep speeds the oscilloscope needs up to 2.5 seconds to generate a trigger and acquisition, therefore, the displayed data is updated for each data sample. The HP 54503A must accommodate two trigger conditions for acquisition and display:

- *auto triggered scroll* is used in **auto trigger**. The oscilloscope acquires and displays data in the auto triggered scroll mode and displays each data sample as it is acquired. As it samples and displays, a message is displayed at the top left corner of the CRT indicating this acquisition mode. A dot moves across the top of the screen at the point of the waveform where data is being acquired.
- *triggered scroll* is used in the **trig'd** mode, requiring scrolled acquisition. Triggered scroll acquisitions are not displayed until all data is available (similar to normal acquisitions) to display. As data is being sampled the advisory **n s to initialize** is displayed while pre-trigger data is collected and **n s to complete** is displayed while post-trigger data is collected. This message indicates the time needed to complete acquisition where **n** is the remaining time (in seconds, s) and countdown continues until the time has elapsed. The advisory **running** is displayed as the write cycle to the screen is executed and displayed data is updated.

If the reference point is set to **left**, the only advisory displayed is **n s to complete** because all data is post-trigger. When right reference is set, all data is pre-trigger and the advisory is **n s to initialize**.

Both entry devices change the time/division sweep speed.

---

## delay Key

Selection of the **delay** function assigns delay as the active function. When delay is set to 0 the trigger event occurs at the delay reference point. Positive delay indicates time after trigger and negative delay indicates time before trigger. Therefore, a delay setting of -50 ns indicates the trigger event occurs 50 ns after the delay reference point.

$$\text{reference} = \text{trigger event} + \text{delay}$$

## reference Key

The reference key changes the delay reference point to one of three reference points:

- left
- cntr (center)
- right

If delay is set to 0, the reference point consists of pre-trigger data to the left and post-trigger data to the right.

## window Key

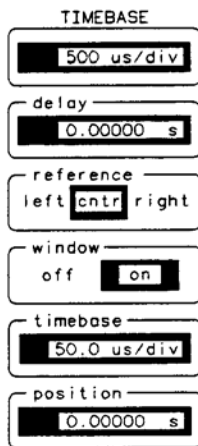

54501/WF09

The window function turns on an expanded timebase and the oscilloscope is placed in a multiple screen mode. The normal waveform, in the original timebase setting, is displayed in the top screen with markers, vertical dotted lines, that enclose a portion of the displayed waveform. Only the enclosed portion, between the markers, is displayed in the bottom screen.

### Note

*The displayed timebase information under the waveform display area is windowed timebase information. When the window is on all measurement results and information are windowed information.*

### Note

*The time base window feature of the HP 54503A is fully operational when acquisitions are running. Once the STOP or SINGLE key is pressed, the latest window display is maintained. The window cannot be changed until the RUN key is pressed again. Waveforms stored in the WAVEFORM SAVE MENU cannot be expanded into the window and all screen information and measurement results are based on the main time base.*

The window feature is much the same as the delayed sweep on an analog oscilloscope, however with the dual screen, the windowed portion of the waveform can be viewed simultaneously.

The timebase of the windowed waveform can be varied from equal to the normal timebase to 1/20 of the normal timebase. This equates to 1/2 of a major division.

When the reference position is set to left, only the right window marker moves when the window timebase is changed. When reference is set to right, only the left marker moves, and when center is selected, both markers move. This maintains a specified time reference without changing any timebase settings and the ability to move the reference points for better viewing.

When the window function is enabled, two selections are available for placing and sizing the window:

- Window timebase
- Window position

**timebase Key** This key is activated only when the window function is turned on and sets the timebase in the window.

As the window timebase is increased the time in the window displayed in the bottom screen is increased. The markers in the top screen move farther apart. When the window reaches full screen the main timebase and the window timebase become equal. As the window timebase is decreased the markers move closer together.

**position Key** This key is activated only when the window function is turned on.

The window can be placed anywhere on the normal waveform. By adjusting the window position you can see any part of the waveform.

### Note

*When window timebase = time/division, there is only one possible setting for window position. Turning the knob will have no effect.*

## Window Exercise

For demonstration on how the window is useful in making measurements and viewing the windowed waveform, perform the following exercise.

### Setting the Input Signal

For this exercise use a simulated ECL input signal, a 1 volt, 2 kHz squarewave with adequate offset to display the signal at midscreen.

Set up an HP 8116A Pulse/Function Generator or another signal generator capable of the same signal.

- Mode = NORM
- Set AMP = 1.00 V
- Set FRQ = 2 kHz
- Set DTY = 50%
- Set OFS = -1.20 V
- Set signal to squarewave

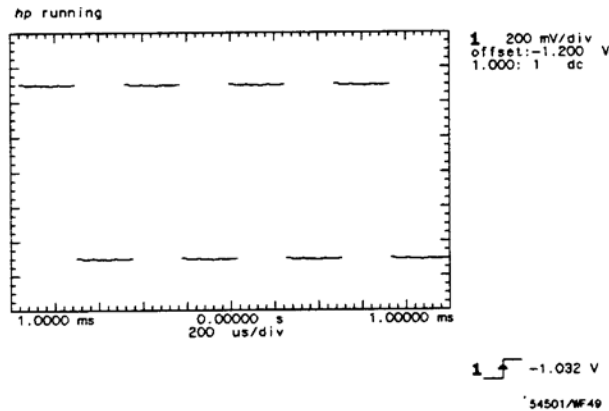

Figure 4-2. Input Signal for Window Viewing

## Setting the Oscilloscope

Input this signal to channel 1 on the HP 54503A and disconnect any inputs to any other channel.

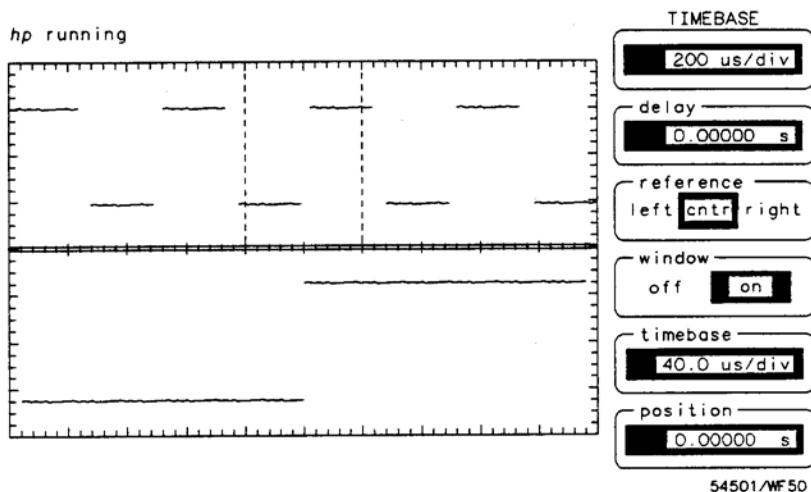

Figure 4-3. Input Signal with Window Turned On

- Press AUTOSCALE (see Figure 4-2).
- Press the TIMEBASE menu key.
- Press the function key to turn on the window.
- Set the window timebase to 40  $\mu\text{s}/\text{div}$  (see Figure 4-3).

### Note

*The timebase factors under the waveform display area have changed to reflect the window.*

## Viewing the Window

The timebase width in the window is 40  $\mu\text{s}$  (1/20 of 1 ms) with the trigger point at center reference and 0 time delay. The knob has the following actions when these fields are active:

- **time/division field (top)** - the knob changes both timebases and displayed waveforms will change until window timebase equals the normal timebase.

- **delay** - the knob moves the window and waveform sideways while maintaining the same size. This allows viewing of the same section of the waveform at a different point in time. The two timebases will not change.
- **window timebase** - the knob changes only the window timebase. The range is from 1/20 of the normal timebase to equal the normal timebase.
- **window position**, as the knob is turned, the window changes position on the normal waveform for viewing different sections of the waveform.

5 - Channel Menu

## Introduction to Channels

The channel menu controls the vertical operation of the HP 54503A. This chapter describes the use of the four channels, including vertical sensitivity, offset, coupling, attenuation and preset levels.

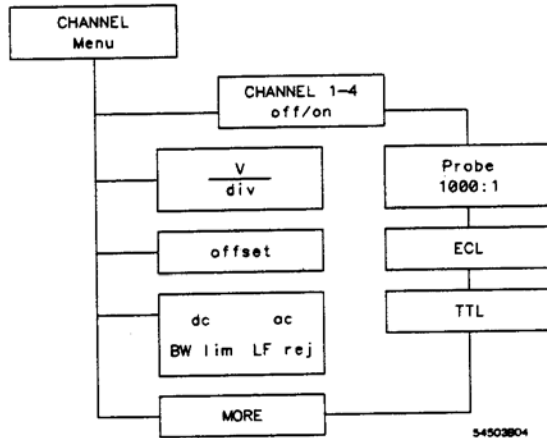
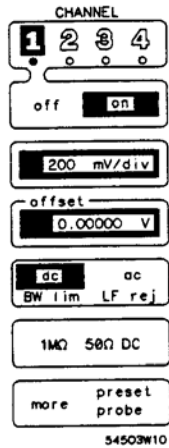

Figure 5-1. HP 54503A Channel Menu

---

## CHANNEL Key

The channel menu is a two level menu. The top key in the channel menu is channel selection. The key toggles channels one through four. When a channel is selected (highlighted in inverse video) it can then be turned on. When a channel is turned on the small circle immediately below the channel number is highlighted.

### Note

*It is possible to have a channel turned on and view it while being in the vertical control menu of another channel. When making changes, ensure the proper channel and function are selected and the intended channels is being changed.*

---

## Vertical Sensitivity Key

The vertical sensitivity key is the third key from the top in the channel menu. The field itself is not labeled, however, the current volts/division is displayed with the units of the current selection. When this function is selected, either of the entry devices can be used for data entry.

The range of the vertical sensitivity for the HP 54503A is from 1 mV/division to 5 V/division. Vertical sensitivity changes in a 1-2-5 sequence in the normal mode or can be changed in the fine mode.

---

## offset Key

When offset is selected, 0 volts is on the vertical midpoint of the display. Offset is the voltage level from mid-screen.

Offset moves the displayed signal up or down, similar to the vertical position adjustment on an analog oscilloscope. However, offset on the HP 54503A has a range of  $\pm 16$  divisions from center screen and is calibrated.

---

## coupling Key

The coupling key has several selection variables:

- ac
- ac bandwidth limit
- dc
- dc bandwidth limit
- LF reject

Bandwidth limit reduces the effective bandwidth to  $\approx 30$  MHz. It reduces the noise in the display path as well as the trigger path.

---

## more Key

The more key toggles the two levels of the channel menu.

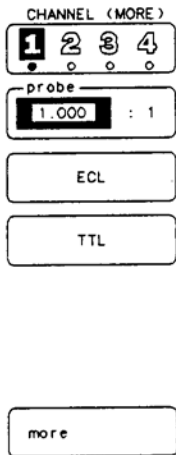

54501/WF 11

---

## probe Key

The probe key selects probe attenuation with a range of 0.9000:1 to 1000:1. Attenuation is adjusted by either knob or entry keypad. When the knob is in coarse mode, adjustments are incremented or decremented in the familiar 1-2-5 sequence. When in fine mode adjustments are in 0.1 increments

Probe attenuation affects scaling factors for the display, not sensitivity at the input.

Attenuation factors are saved with the front panel setup.

---

## ECL Key

The ECL key sets the oscilloscope to levels optimized for ECL circuits:

- V/Div: 200 mV/div
- offset: -1.3 V
- coupling: dc
- Trigger level: -1.3 V
- Trigger slope: no change

RECALL 0 returns the menu to the previous settings.

---

## TTL Key

The TTL key sets the oscilloscope to levels are optimized for TTL circuits:

- V/Div: 1 V/div
- offset: 2.5 V
- coupling: dc
- Trigger level: 1.4 V
- Trigger slope: no change

To return to the previous settings press RECALL 0.

**6 - Trigger Menu**

---

## Introduction to the Triggers

The trigger modes of the HP 54503A provide many distinctive techniques to trigger and capture data. The triggering capabilities range from simple edge triggering to logic triggering on multiple signals.

This chapter contains descriptions of the triggering modes, explanations on how to use them, and exercises detailing some real life applications. The HP 54503A has five triggering modes:

- edge
- pattern
- state
- delay
- tv

---

## Trigger Mode Interaction

The trigger level (threshold) for each channel is set in the edge trigger mode and is independent for each channel. It is carried over to all other modes, except the tv trigger mode. These levels are important settings because the high and low levels in the pattern, state, and delay modes are greater than or less than the trigger level.

The tv trigger level is a special case and is set in the tv trigger menu.

## Edge Trigger Mode

The edge trigger mode has the following selections:

- trig'd/auto
- trigger source
- trigger level
- slope
- holdoff

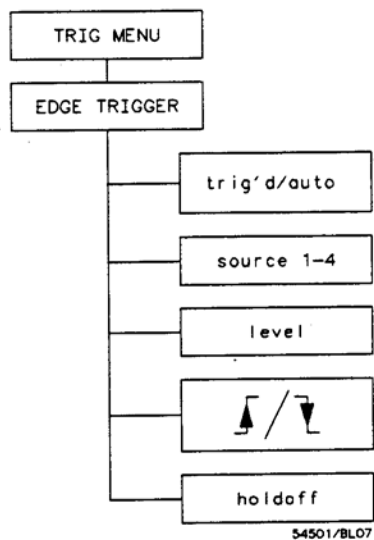

*Figure 6-1. Edge Trigger Menu*

### trig'd/auto Key

The trig'd/auto selection toggles between the two trigger modes. The current selection is displayed in inverse video. This field is available in all trigger menus.

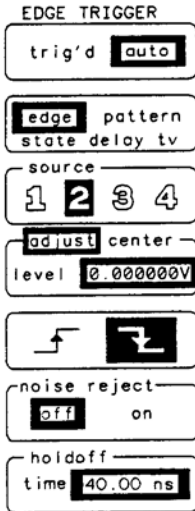

54503w11

### source Key

This key selects the trigger source. The options are channels 1-4. The current selection is highlighted in inverse video.

### adjust/center Key

This key sets the trigger level. The range on this function is  $\pm 6$  divisions from center. It provides flexibility for setting exact triggering points and specifies levels used in the more sophisticated triggering modes.

### slope Key

This field is not labeled, however, the available selections are graphic representations of the rising edge and falling edge. The current selection is highlighted in inverse video.

### noise reject Key

Turn the noise reject on for triggering on noisy signals to avoid the problem of false triggering.

### holdoff Key

Pressing the holdoff key assigns the entry devices to control holdoff. Holdoff disables the trigger circuit for a selectable time period or number of events after the trigger event. Holdoff is selected in time units, from 40 ns to 320 ms, or in number of edges, 2 to 16000000.

---

## Holdoff Exercise

This exercise sets up the oscilloscope and a signal generator to view some of the features of the edge trigger. Holdoff is used to gain a stable trigger. This technique is not necessary for most applications and waveforms, however, for many non-recurring and irregular waveforms it is useful.

**Instrument Setup** Follow the instructions for setting up the signal generator. The signal for this exercise is a burst pattern with two positive cycles that repeats every 5  $\mu$ s. Use an HP 8116A Pulse/Function Generator with the burst option or a signal generator capable of the same signal.

Make the following settings:

- MODE: I.BUR
- RPT: 5.00  $\mu$ s
- BUR: 2
- FRQ: 1 MHz
- DTY: 50%
- AMP: 1 V
- OFS: -200 mV
- Set the signal for a square wave.

**Oscilloscope Setup** Connect the the signal generator to the channel 1 input and disconnect all other inputs.

- Press AUTOSCALE (see Figure 6-2).

hp running

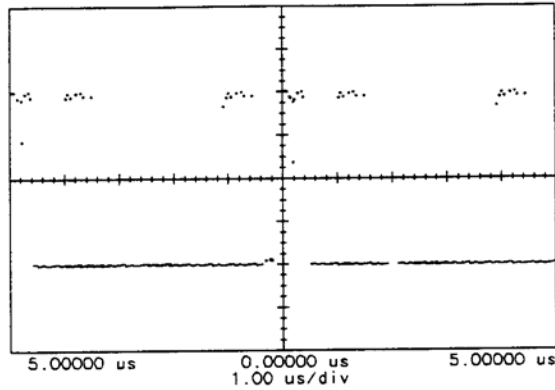

1 200 mV/div  
offset: -225.0 mV  
1.000: 1 dc

1 ↕ -225.0 mV  
54501/WF59

*Figure 6-2. Two-Burst Waveform after Autoscale*

- Select the **TIMEBASE** menu.
- Set the sweep speed to **500 ns/div**.

hp running

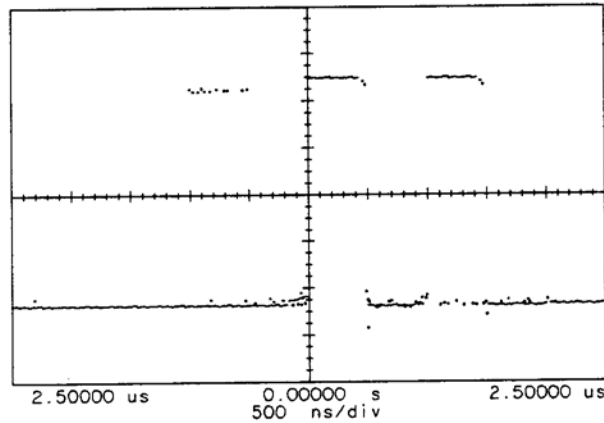

TIMEBASE

500 ns/div	
delay	0.00000 s
reference	left <b>cntr</b> right
window	<b>off</b> on

54501/WF58

*Figure 6-3. Two-Burst Pulse*

The HP 54503A sets up the display parameters. It is now attempting to trigger on the first rising edge of the two cycle burst.

- Enter **TRIGGER MENU** and press the slope key.

The oscilloscope is now triggering on the first falling edge of the two cycle burst. Press the **slope** key again to trigger on the positive edge.

#### **Note**

*The signal generator is set for two 500 ns pulses. The display on the oscilloscope appears to have three pulses. This is an unstable trigger condition. The following steps explain this condition and how to overcome it.*

- Press the **holdoff** key.
- Set **holdoff** to 1.02000  $\mu$ s, using either of the entry devices.

Holdoff on the HP 54503A has a minimum time setting of 40 ns. The input signal to the oscilloscope has two 500 ns pulses. On the first rising edge a trigger occurs and activates the 40 ns holdoff. When the holdoff time has elapsed the oscilloscope triggers on the next rising edge. The oscilloscope times a 40 ns holdoff and looks for another trigger. The oscilloscope triggers on the first rising edge of the second burst. Each trigger event occurs on a different pulse, and consequently the trigger condition is unstable.

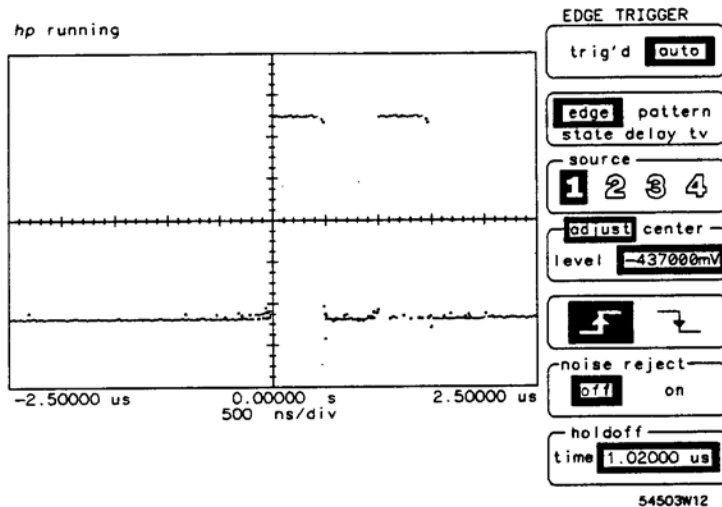

*Figure 6-4. Two-Burst Pulse w/Stable Trigger*

By adjusting the holdoff to wait until the rising edge of the second pulse passes, the oscilloscope triggers only on the first rising edge and the signal is stable. In this case the trigger becomes stable with approximately 1.02  $\mu$ s holdoff.

## Pattern Trigger Mode

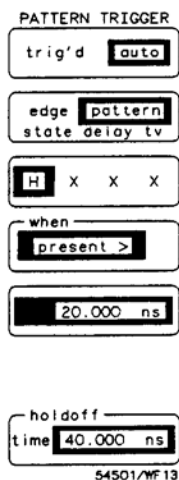

54501/WF 13

The pattern mode defines a four-bit pattern for the oscilloscope to recognize and then generate a trigger event. When the inputs satisfy the trigger pattern and conditions, the HP 54503A triggers and displays the desired portion of the waveform. The logic highs (H) and lows (L) use the threshold set in the edge trigger as the reference level.

The pattern mode is very useful for glitch detection because the HP 54503A can trigger on a glitch as narrow as 1.5 ns.

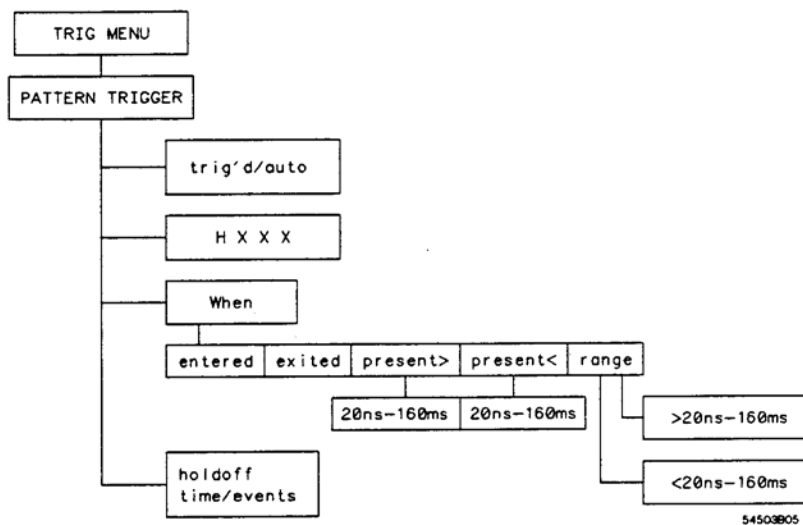

54503B05

Figure 6-5. Pattern Trigger Menu

The top two function keys remain the same as the Edge Trigger mode.

**pattern Key** This is an unlabelled field. The display depicts the 4-bit pattern. The active field is displayed in fullbright and can be changed with the knob. The function key changes the bit selection of three levels:

- H - high
- L - low
- X - don't care

The criteria for high is higher than the current trigger level, and low is lower than the current trigger level set in the edge trigger menu.

The 4-bit pattern is representative of the four-channel input.

For example, if the pattern is LXXH, the voltage on channel 1 must be lower than the trigger level set for channel 1, channels 2 and 3 are don't cares so the input levels are disregarded, and the channel 4 input must be higher than the trigger level set for channel four. If these conditions are satisfied by the inputs, then the oscilloscope generates a trigger event.

#### **Note**

*When any channel is not being used in the qualifier pattern, it should be set as don't care. The trigger level is still compared to the no input channel and a high or low is determined. The only true don't care is X.*

If the pattern XXXX is selected, a trigger event does not occur because a trigger event is not defined.

**when Key** This key controls five sets of conditions that must be satisfied to generate a trigger event. These conditions are as follows:

- **when entered:** a trigger is generated on the first transition that makes a pattern true. The pattern must be false and go true to generate the trigger.
- **when exited:** a trigger is generated on the first transition that makes the pattern false. The pattern must be true and go false to generate a trigger.

- **when present >** : a trigger is generated when a trigger pattern is true longer than a specified minimum time period. This time period is specified in the next selection key that is activated when present > is selected. The present > time ranges from 20 ns to 160 ms.
- **when present <** : a trigger is generated when a trigger pattern is true less than a specified maximum time period. This time period is specified in the next selection key that is activated when present < is selected. The present < time ranges from 20 ns to 160 ms and pulses as narrow as 1.5 ns generate a stable trigger.
- **range**: this trigger condition is a combination of present < and present >. A trigger is generated when a trigger pattern is true for longer than a specified minimum and shorter than a specified maximum time period. These time periods are specified in the next two selection keys that are activated when range is selected. The first range time setting must be less than the second range time setting.

**holdoff Key** The holdoff key assigns the entry devices to control holdoff. Holdoff disables the trigger circuit for a selectable time period or number of events after the trigger event. Holdoff is selected in time units, from 40 ns to 320 ms and incremented in 20 ns intervals, or in number of patterns from 2 to 16000000.

---

## Pattern Trigger Exercise

This exercise demonstrates how to define the 4-bit pattern and how it affects the trigger and the resulting display.

### Note

*Set the trigger level for each trigger source while in the edge mode. These trigger levels must be set before going into the pattern mode, or proper triggering may not occur.*

**Instrument Setup** To perform the following exercise use the HP 8116A Pulse/Function Generator, or another function generator capable of producing the same 1 MHz, 1 volt, squarewave signal.

Set up the HP 8116A Pulse/Function Generator:

- Mode = NORM
- FRQ = 1.00 MHz
- DTY = 50%
- AMP = 1.00 V
- OFS = -2.00 V
- Pulse = squarewave

Connect the signal to a BNC tee on channel 1 using a 1-meter coaxial cable. Connect another 1-meter cable from the other side of the BNC tee to channel 4.

### Oscilloscope Setup

The extra cable length between channels 1 and 4 provides a time delay between the signals displayed on the oscilloscope. The propagation of a 1-metre coaxial cable is approximately 6 to 7 ns. This time delay is used to demonstrate the HP 54503A triggering capability.

- Press AUTOSCALE.

Set up the HP 54503A as follows:

- Timebase = 10.00 ns/div  
delay = 0.00 s  
reference = cntr  
window = off
- Channel 1  
Vertical sensitivity = 500 mV/div  
offset = -200.00 mV  
dc coupling
- Channel 4  
Vertical sensitivity = 500 mV/div  
offset = -200.00 mV  
dc coupling

- Display
  - zero persistence
  - 2 screens
  - axes
- Trigger
  - Channel 1 level = -200 mV
  - Channel 4 level = -200 mV
  - Set the trigger mode to pattern.

Set the pattern to HXXL as follows:

- Press the function key until the first character is highlighted.
- Turn the knob until the highlighted area is H.
- Select the next character in the pattern and repeat the procedure.
- Continue until all characters are selected in the HXXL pattern.
- Press the **when** key until **entered** is selected.

The display should be similar to the following figure.

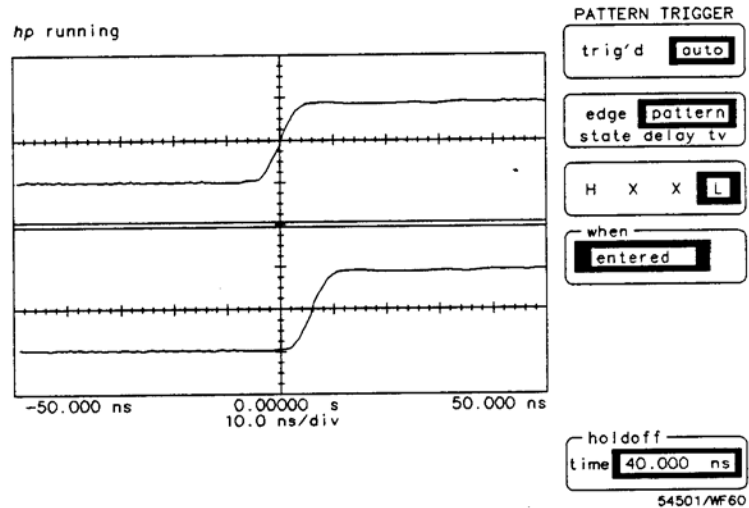

Figure 6-6. HXXL when entered Pattern

Channel 1 is displayed in the top screen. To satisfy the conditions of the bit pattern, channel 1 must be high (higher than the channel 1 trigger level or greater than -200 mV). When the signal on channel 1 goes higher than -200 mV and channel 4 is still low (less than -200 mV) the pattern conditions have been satisfied as the signal is entering the trigger conditions and the HP 54503A triggers.

- Press the when key and change the condition to when exited.

The oscilloscope triggers on the first transition that makes the bit pattern false, in this case when channel 4 goes high.

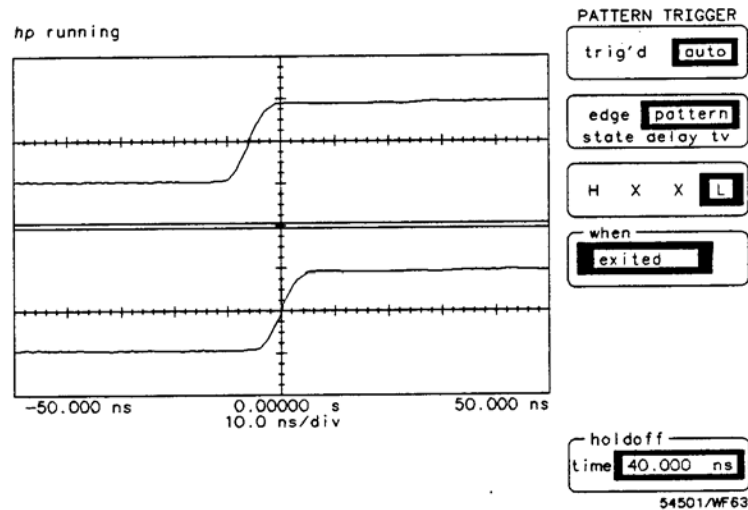

Figure 6-7. HXXL when exited Pattern

- Change the bit pattern to HXXH and select the entered condition.

To satisfy this bit condition both channels must be high. The oscilloscope does not trigger until channel 4 goes high while channel 1 is high.

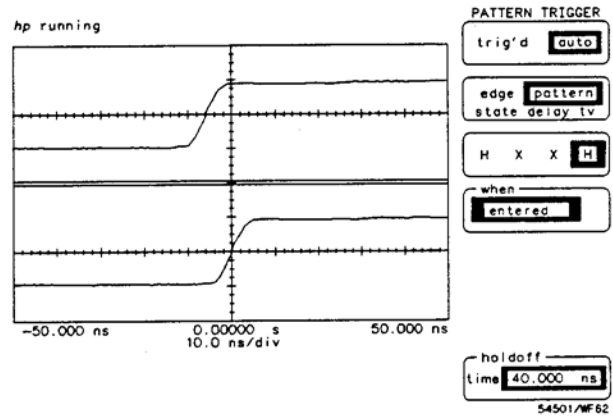

Figure 6-9. HXXX when entered Pattern

- Change the trigger condition to **when exited**.

While channel 4 is still high, when channel 1 goes low the bit pattern is no longer true and the HP 54503A triggers.

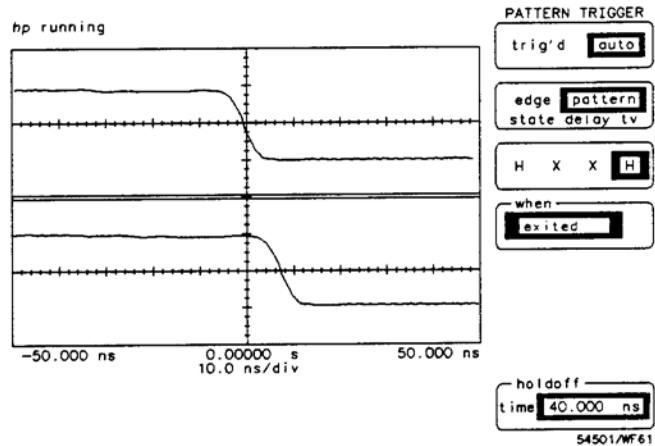
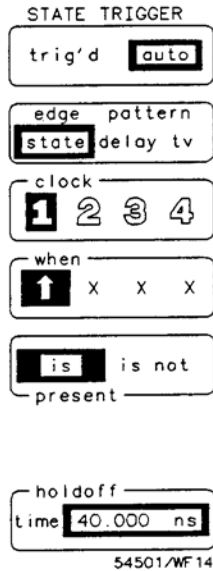

Figure 6-8. HXXX when exited Pattern

## State Trigger Mode



The state trigger mode is similar to the pattern trigger mode except that one channel is selected as a clock edge and the other three channels define a pattern. When the pattern becomes true the HP 54503A triggers on the next clock edge if the pattern meets setup and hold criteria.

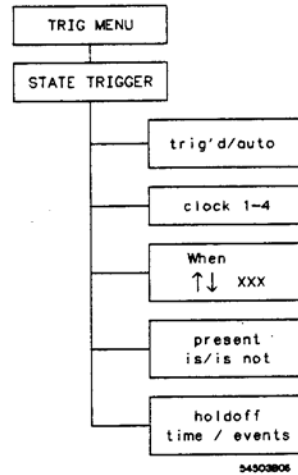

Figure 6-10. State Trigger Menu

The **trig'd/auto** and trigger mode function keys remain displayed in all trigger modes.

- clock Key** Select any channel to be used as the state clock. Select the channel by pressing the function key until the desired channel is highlighted. The clock selection is reflected in the next field with an arrow, pointing either up for a positive slope or down for a negative slope.
- when Key** The when key depicts the desired pattern. The displayed pattern shows the arrow at the selected clock channel. The other three channels define the logic pattern that must be satisfied to generate a trigger event using the H, L, X convention described in the pattern trigger mode.

To change the pattern:

- Press the function key until the bit to be changed is highlighted.
- Rotate the knob until the desired setting is highlighted.
- Select the arrow to change the trigger slope, if necessary, and turn the knob until the desired settings appear.

**present Key** A trigger event is generated on the selected edge when the pattern is true and is **present** is selected, or a trigger occurs when the pattern is false and **not present** is selected.

**holdoff Key** The **holdoff** key assigns the entry devices to control holdoff. Holdoff disables the trigger circuit for a selectable time period or number of events after the trigger event. Holdoff is selected in time units, from 40 ns to 320 ms, or number of patterns, 2 to 16000000.

---

## State Trigger Exercise

This exercise demonstrates how an input pattern is used to qualify a clock edge as a trigger.

State triggering extends the logic triggering capability of the HP 54503A by selecting one of the inputs as a clock and using the other inputs as qualifiers.

This is useful when it is necessary to synchronize the display with a system clock to detect a system state. For example, consider a synchronous memory bus. The state trigger mode enables only those events that occur when reading from a block of memory to be captured and displayed.

**Instrument Setup** To perform the following exercise use an HP 8116A Pulse/Signal generator or another signal generator capable of the same 1 MHz, 1 volt squarewave.

Set up the HP 8116A as follows:

- Mode = NORM
- FRQ = 1.00 MHz
- DTY = 50%
- AMP = 1.00 V
- OFS = -200 mV

Connect the signal to a BNC tee on channel 1 using a 1-meter coaxial cable. Connect another 1-meter cable from the other side of the BNC tee to channel 4.

### Oscilloscope Setup

The extra cable length between channels 1 and 4 provides a time delay between the signals displayed on the oscilloscope. The propagation of a 1-meter coaxial cable is approximately 6 to 7 ns. This time delay demonstrates the HP 54503A triggering capability.

- Press AUTOSCALE.

Set up the HP 54503A as follows:

- Timebase = 10.00 ns/div  
delay = 0.00 s  
reference = cntr  
window = off
- Channel 1 turned on  
Vertical sensitivity = 400 mV/div  
offset = 1.25 V  
dc coupling
- Channel 4 turned on  
Vertical sensitivity = 400 mV/div  
offset = -75 mV  
dc coupling
- Display  
zero persistence  
2 screens

- **Trigger**  
 Channel 1 level = 125 mV  
 Channel 4 level = -100 mV  
 Set the trigger mode to state
- Set the pattern to ↑XXL as follows:
  1. Press the function key until the first bit is highlighted.
  2. Turn the knob until the highlighted area is ↑.
  3. Select the next bit in the pattern and select H
  4. Continue until all bits are selected in the ↑XXL pattern
- Press the when key until **is present** is selected (see Figure 6-11).

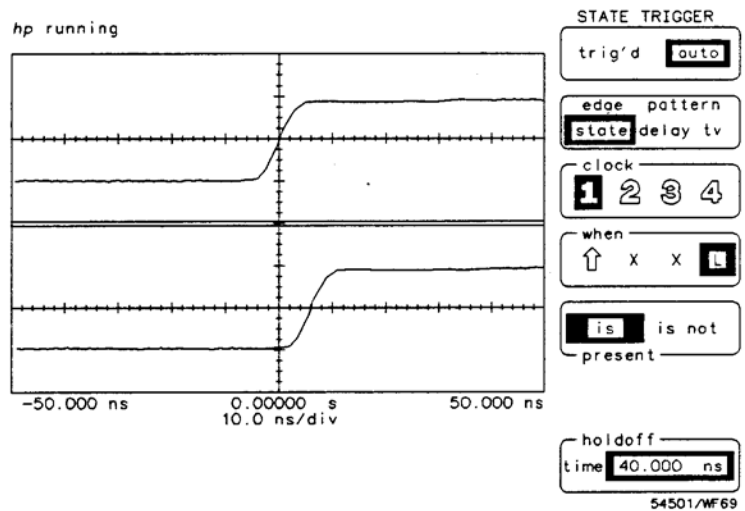

Figure 6-11. Channel 1 Clock XXL State

Channel 1 is displayed in the top screen. To satisfy the conditions of the bit pattern, channel 4 must be high (higher than the channel 4 trigger level or greater than 125 mV). When the signal on channel 1 goes higher than 125 mV and channel 4 is still low (less than -100 mV) the pattern conditions have been satisfied, the HP 54503A triggers on the next positive pulse on channel 1.

- Press the **is/is not present** key and change the condition to **not present**.

The pattern becomes false when channel 4 turns high.

- Change the bit pattern to  $\uparrow$ XXH and select the **is not present** condition.

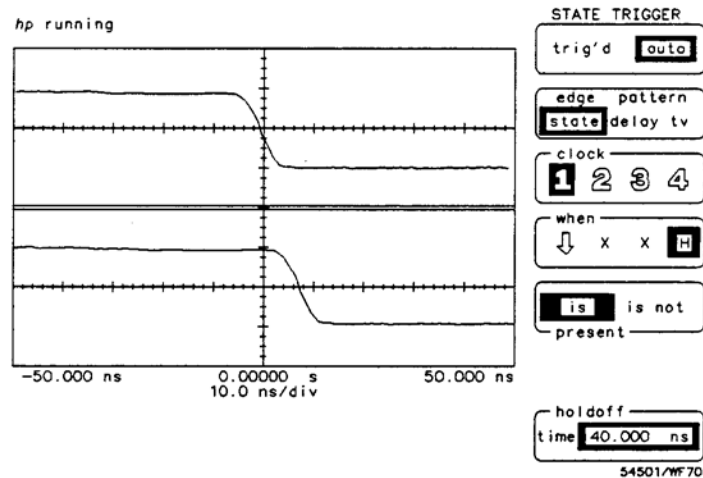
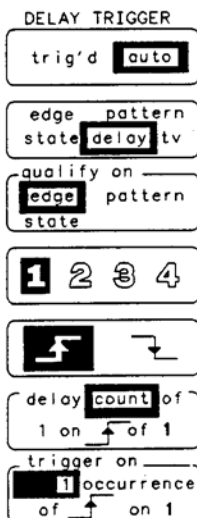

Figure 6-12. Channel 1 Clock XXH State

To satisfy this bit condition the clock channel must go low while channel 4 is high. The oscilloscope does not trigger until channel 1 goes low while channel 4 is high.

## Delay Trigger Mode

The delay trigger mode qualifies on a signal edge, pattern, or state, delay for a period of time (or occurrence of edges), and then triggers on a selected edge from any source.



This trigger mode is versatile and accommodates most complex triggering situations. It has the flexibility to select different trigger sources, delay times, delay counts and then display various points of the waveform. A trigger holdoff of 40 ns occurs after the delayed trigger happens.

### qualify on Key

The **qualify on** key selects which mode to qualify the trigger before a delay is defined.

The options are:

- edge
- pattern
- state

### qualify on edge

Select the edge qualifier and the next two function keys define the parameters. The first key following the qualify on edge key is an unlabelled field that selects the channel to be the source. The second key below the edge selection is the slope selection.

**qualify on pattern** When the pattern trigger option is selected, the next function key defines the qualifier pattern. Defining a pattern is the same as in the pattern trigger mode.

- Highlight the bit to be changed by pressing the function key.
- Change the bit by rotating the knob.

After selecting through all four bits, the active field is changed to the condition field. This field to sets conditions as in the pattern trigger mode:

- when entered
- when exited
- when present >
- when present <
- range

These settings activate the next field, as appropriate, so the specific time parameters can be set.

**qualify on state** If the state trigger option is selected the next two function keys define the state conditions.

As in the state trigger mode, select the channel to define the state clock. This selection is reflected in the pattern with an arrow and the slope is depicted with the arrowhead pointing up or down. Use the function key to move the highlighted bit to change the pattern. When the pattern is set, the **is/not present** setting can be changed by moving the highlight to the **is/not present** field label and pressing the function key again. When the label is highlighted, toggle the setting between **is/not present** with the knob.

**delay Key** This field selects between two delay options. To change between the **time** and **count** options rotate the knob until the desired option is displayed in the inverse video field.

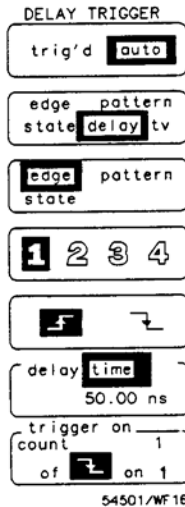

54501/WF 16

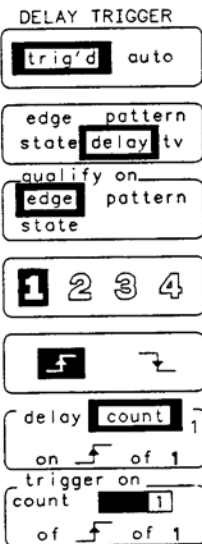

54501/WF 84

**Trigger Menu**  
6-22

**delay time** disables the trigger circuit for a selected period of time, from 30 ns to 160 ms after the trigger has been qualified

#### Note

*Time delay is not available in the time qualified pattern settings of when present >, when present <, or range*

- Press the function key until the highlight is on the first numeric field. This field selects the amount of delay after qualification, ranging from 30 ns to 160 ms.

**delay count** (delay by edges) disables the trigger circuit for a selected count from 1 to 16,000,000 or a delay by events (**time**), after the trigger has been qualified. After the selected count has been attained the HP 54503A will look for the user specified trigger edge.

- Press the function key until the highlight is on the first numeric field. This field to selects the number of edges to delay after the trigger has been qualified (from 1 to 16,000,000).
- Press the function key once more to activate the **rising edge/falling edge** option and select the desired edge using the knob.
- Press the function key once more to **highlight** the third option field and select the channel to delay on.
- Press the function key a fourth time to return to the first numeric field.

HP 54503A  
Front-Panel Reference

**trigger on Key** This key selects a specific edge to trigger on after the qualification and delay conditions have been satisfied. All other keys in this menu have dealt with defining qualifying conditions, however, this field sets the trigger point. This is another three position option switch.

- Press the function key to highlight the numeric field and select which occurrence to trigger, using the knob to set the number (1 to 16,000,000).
- Press the function key again and move the highlighted field to select the slope. The knob toggles the selection between rising and falling edge.
- Press the function key again and highlight the channel selection. The knob is used to change the channel selection.

---

## Delay Trigger Exercise

This exercise demonstrates how to use the delay trigger and trigger on the exact point of a waveform. The exercise leads through setting up a complex signal, setting up the HP 54503A, and changing settings and counts for viewing various points on the waveform.

**Instrument Setup** Set up an HP 8116A (or comparable signal/generator) for a burst pulse with ten bursts that repeats every 50  $\mu$ seconds.

Set up the HP 8116A Pulse/Function Generator:

- Mode = I.BUR
- RPT = 50  $\mu$ s
- BUR = 10
- FRQ = 5.0 MHz
- DTY = 50%
- AMP = 1.00 V
- OFS = -200 mV

Connect the signal to channel 1 of the HP 54503A.

**Oscilloscope Setup** The HP 54503A autoscales and displays this signal, however, for this example make the listed triggering changes after autoscaling.

- Press AUTOSCALE.

hp running

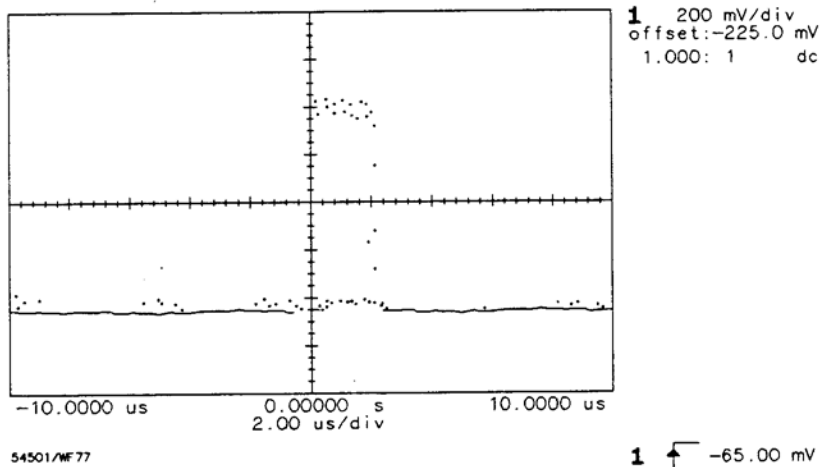

*Figure 6-13. Ten Burst Pulse after AUTOSCALE*

Set up the HP 54503A as follows:

- Press TRIG and select **trig'd** display.
- Select **delay** trigger mode.
- **Qualify on edge** and the rising edge of channel 1 as the source.
- Select a delay time of **2.5  $\mu$ s** to gain a stable trigger.
- Set **trigger on** to trigger on rising edge 1 of channel 1.

This trigger setup qualifies on the first rising edge of the burst, delays through the remaining portion of the burst, then triggers on the specified edge of the next burst.

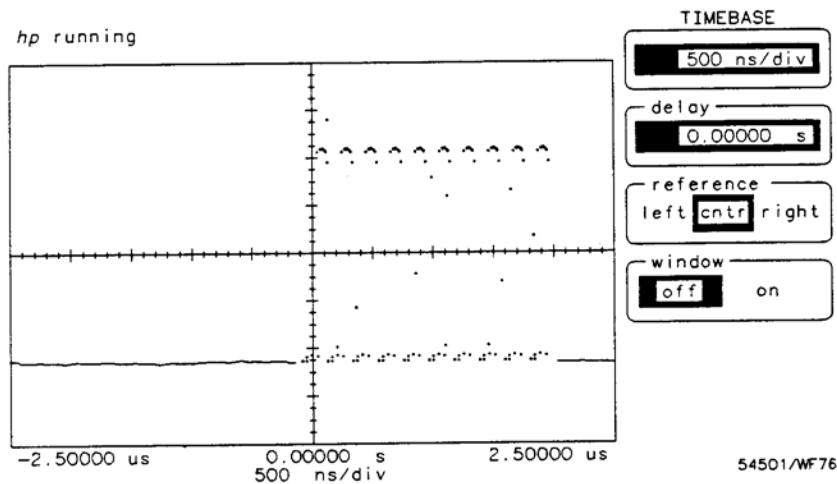

Figure 6-14. Ten Burst Pulse w/Stable Trigger

- Press TIMEBASE and set time/division to 500 ns.
- Return to the trigger menu and set trigger on count to 5. This tells the oscilloscope to trigger on the 5th rising edge of the burst (see Figure 6-15).

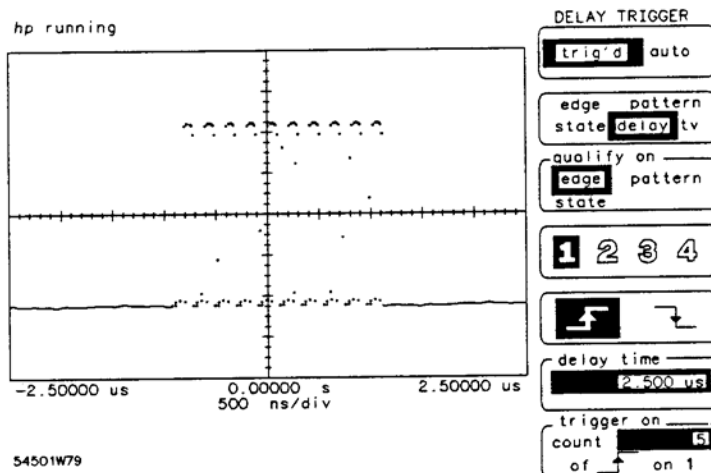
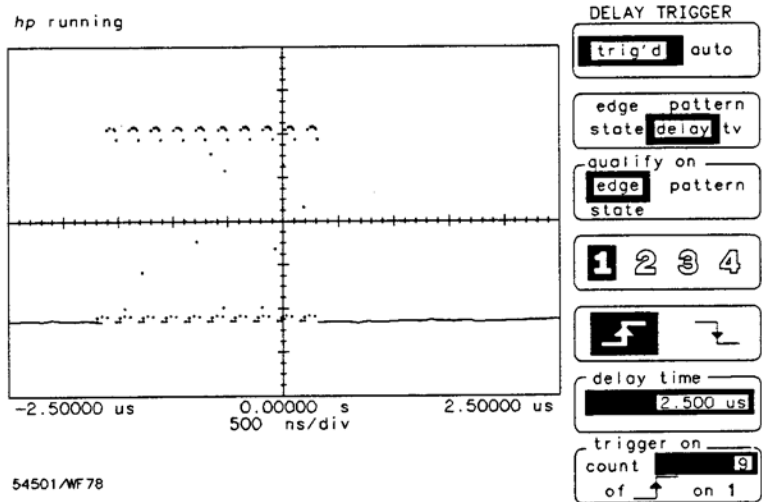

Figure 6-15. Ten Burst Pulse Triggered on Pulse 5

- Change the trigger on count key to 9 (see Figure 6-16).

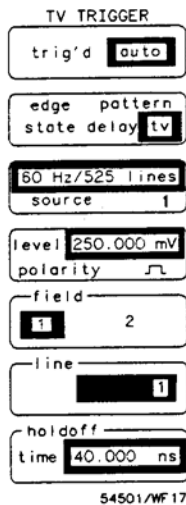

*Figure 6-16. Ten Burst Pulse Triggered on Pulse 9*

By setting the oscilloscope to the delay trigger mode, a specific time or count to delay between qualification and trigger can be added.

In this exercise, the trigger was delayed to get a stable display. When the time delay had elapsed the HP 54503A began counting rising edges until it found the edge set.

## TV Trigger Mode



The TV TRIGGER menu enables the HP 54503A to trigger on clamped tv signals. The two most common tv standards; 60 Hz/525 lines or NTSC is the standard used in the United States, 50 Hz/625 lines is the standard used in most European countries. This trigger menu also allows for user defined tv signals that may be used in other parts of the world.

To move the highlighted inverse video window within a field you must press the selection key and to change the value displayed in the window you must rotate the knob.

### Note

*Pay close attention to the movement of the highlighted window; it moves to various options within the field.*

### Standard Select Key

The source key chooses between the NTSC standard tv signal used in the United States with a 60 Hz and 525 lines per frame, the standard of 50 Hz and 625 lines per frame used in most countries in Europe. The third option is for user defined ranges of the tv signal.

To make the desired selection:

- Press the selection key and select the standard by rotating the knob. The active field is highlighted in inverse video.

### Source Select Key

To select the trigger channel to be used as a source,

- Press the function key and move the highlighted field, rotate the knob until the desired channel is displayed.

**level/polarity Key** The level option sets the trigger level that is applicable only to the tv trigger source.

- Press the function key again and the highlighted window moves to the polarity option and selects the rising edge or falling sync pulses to trigger on.

**field Key** The field key selects field, 1 or 2.

**line Key** The line key selects which line the trigger will be generated on. This selection is dependent upon which field has been selected previously.

If the previous selection is the 60 Hz, 525 lines standard, the options available depend upon which field, 1 or 2 is selected:

- If field 1 is selected, select from line 1 to 263 in field 1.
- If field 2 is selected, choose from line 1 to 262 in field 2.

This tv trigger mode is compatible with broadcast standard M.

If the 50 Hz, 625 lines standard is selected, the options are also dependent upon field settings:

- If field 1 is selected the range of lines is from 1 to 313,
- If field 2 is selected the range of lines is from 314 to 625.

This tv trigger mode is compatible with broadcast standards: B, C, D, G, H, I, K, K1, L, and N.

**holdoff Key** The holdoff key enables the oscilloscope to hold off the trigger event from 40 ns to 320 ms and is incremented in 20 ns time frames.

---

## TV Trigger Exercise

Video signals are unique, and as such have unique requirements for proper triggering. This exercise demonstrates how to display and work with video signals on the HP 54503A.

**Instrument Setup** Use a standard NTSC signal generator with clamped video output for this exercise. Turn color bars on.

**Oscilloscope Setup** Connect the NTSC video signal to channel 1 of the HP 54503A.

- Press AUTOSCALE.
- Select the tv trigger mode.
- Set 60 Hz/525 lines and channel 1 as the source.

Determine the polarity of the sync pulse.

- Select the trigger level and rotate the knob until a stable display is attained. When a sync pulse is visible, determine the polarity, select polarity (press the function key) and set the sync pulse in accordance with the actual pulse.
- Set the trigger level at approximately the midpoint of the sync pulse.

This sets the trigger level just below the middle of the sync pulse and tells the oscilloscope to trigger on the leading edge.

- Set trig'd/auto to trig'd.

This eliminates the possibility of a premature trigger event occurring.

- Select field 1 and line 1.
- Press TIMEBASE and set time/division to 100  $\mu$ s/div.

- Press DISPLAY and set persistence to  $\approx 600.0$  ms to accommodate video signals.

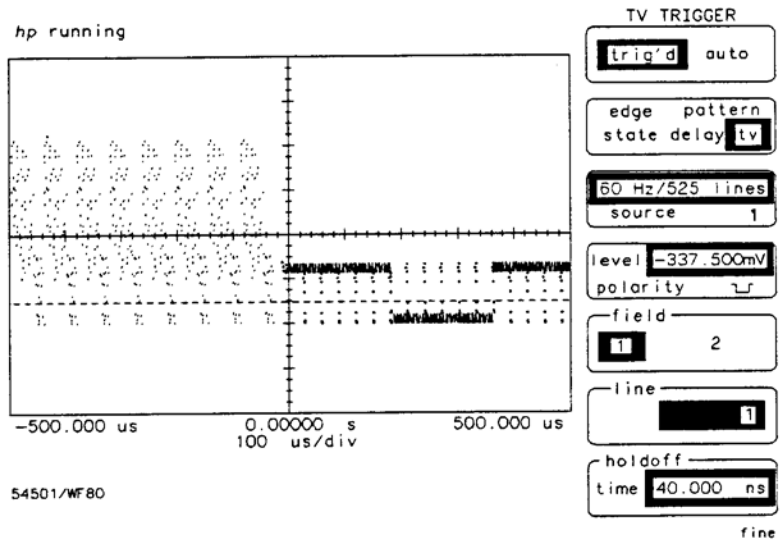

Figure 6-17. Trigger at Field 1, Line 1

The HP 54503A is triggering on the first equalizing pulse of field 1, the first pulse in the vertical interval. The pretrigger data that is being viewed (left half of the screen) is field 2, lines 256-262.

- Set time/division to  $10 \mu\text{s}/\text{div}$  and set the trigger to field 1, line 10.

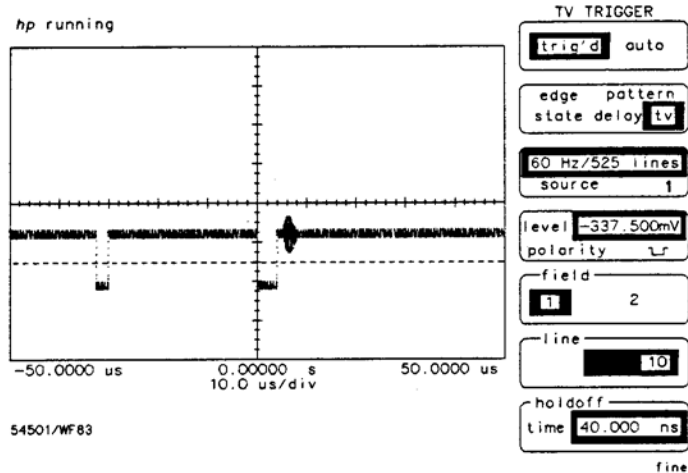

Figure 6-18. Trigger on Field 1, Line 10

The trigger is now on the first horizontal sync pulse in the vertical interval with color burst information.

- Change the trigger point to field 1, line 21.

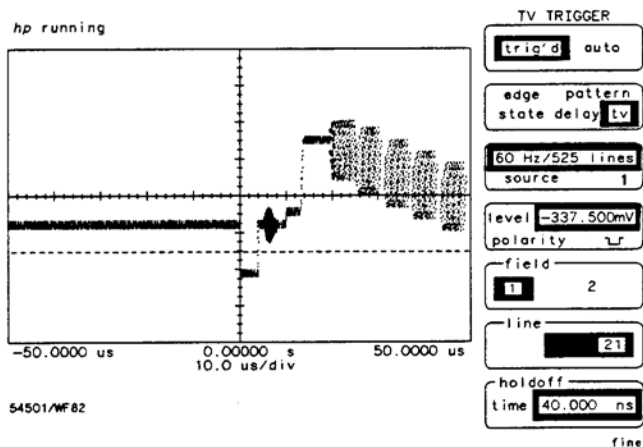

Figure 6-19. Trigger on Field 1, Line 21

The trigger point is now on the last sync pulse of the vertical interval. The next line contains color information, in this case color bars are present.

- Change the trigger to field 2, line 1.

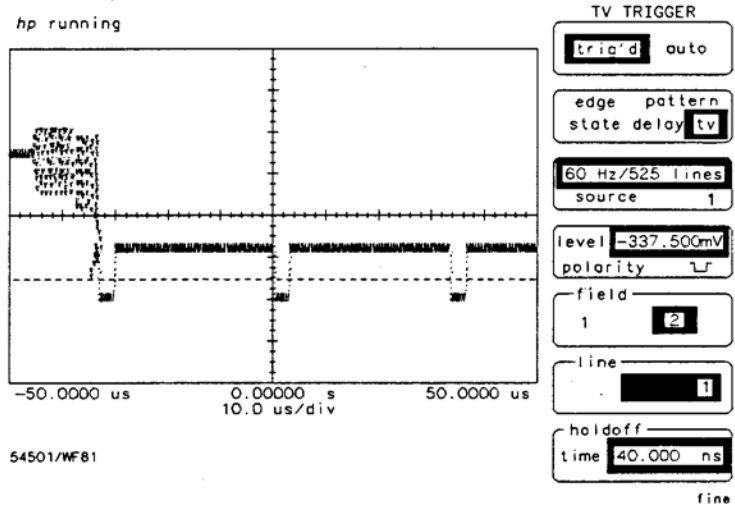

Figure 6-20. Trigger on Field 2, Line 1

The trigger point is on the second sync pulse of the vertical interval. This is the correct trigger point because fields 1 and 2 are interlaced.

7 - Display Menu

## Introduction to the Display

The **DISPLAY** menu controls most of the features that dictate how the acquired data is displayed. These features include ways to manipulate data for clarity, to eliminate noise, viewing best case/worst case situations, or the displayed background.

This chapter describes the **DISPLAY** menu, three submenus, how to control all the features, and how to display the most meaningful waveform for measurements.

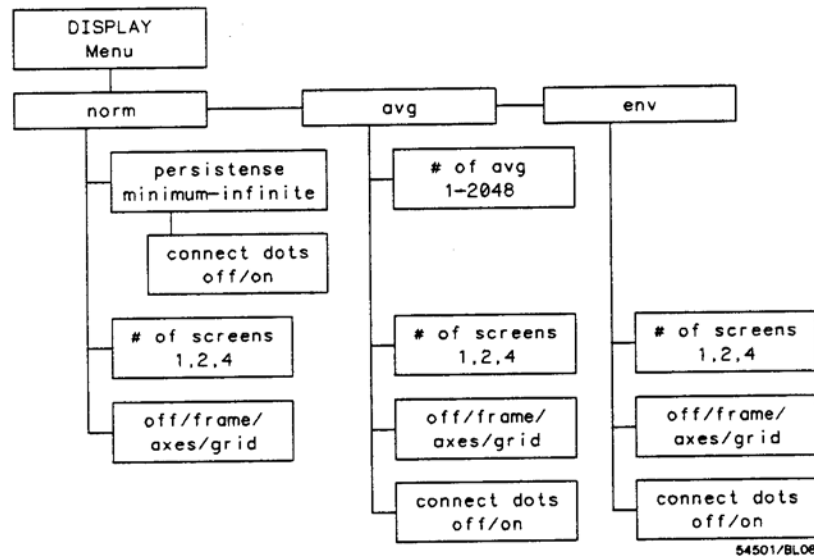

Figure 7-1. Display Menu

## Display Mode Key

The display mode key selects one of the three display modes:

- normal
- averaged
- envelope

**norm** The **norm** mode sets the time parameters for displaying data, or persistence. The range in the variable persistence mode is from minimum, which rewrites the waveform on each acquisition, to infinite which maintains acquired waveforms on the screen indefinitely. Settings in-between, from 200 ms to 10 seconds are also selectable. This means data display records can be preset to any of the persistence settings.

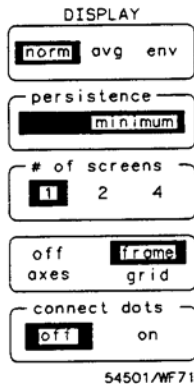

- Minimum persistence rewrites each waveform on the display as it is acquired. The current display is always the most recent acquisition.
- Variable persistence settings are useful when the input signal is changing and immediate feedback is needed.
- Longer persistence is useful when observing long-term changes in the signal or low signal repetition rates.
- Infinite persistence can be used for worst-case characterizations of signal noise, jitter, drift, etc. In this mode the HP 54503A is used as a storage oscilloscope and is without the fade or bloom of an analog oscilloscope.

When the keypad is used to change persistence settings, any entry longer than 10 seconds displays the message **value out of range, set to limit** and persistence is set to **infinite**. Any entry less than 200 ms displays the same message and persistence is set to **minimum**.

Connect-the-dots is available only when in **norm** mode and **minimum** persistence.

either of the entry devices. Connect the dots is only available when in norm mode and minimum persistence.

**avg** The averaged mode selects the number of waveform acquisitions that are averaged to generate the displayed waveform. The range for the averaging function is 1-2048 in powers of 2.

DISPLAY

norm **avg** env

# at avg  
[██████████] 32

# of screens  
**1** 2 4

off **frame**  
axes grid

connect dots  
**off** on

54501/WF72

When averaged mode is selected the next function key is activated and the number of averages is set with either entry device.

Displayed signal noise is significantly reduced using the averaging mode. As the number of averages is increased from 1 to 2048, the display becomes less responsive to changes to the input signal(s), however, using more averages reduces the effects of displayed signal noise and improves resolution.

**env** The envelope mode needs no other parameters set. The display reflects the minimum and maximum voltages in each horizontal position. This is useful in viewing voltage or time jitter.

DISPLAY

norm avg **env**

# of screens  
**1** 2 4

off **frame**  
axes grid

connect dots  
**off** on

54501/WF73

---

## # of screens Key

The next function key chooses the number of screens to view:

- **1:** the entire display area is one screen and any displayed waveforms are superimposed on top of each other.
- **2:** the display area is divided into two screens. Channels 1 and 2 will be displayed in the top screen and channels 3 and 4 will be displayed in the bottom screen (See Figure 7-2).
- **4:** the display is divided into four equal screens with one waveform displayed in each screen (See Figure 7-3).

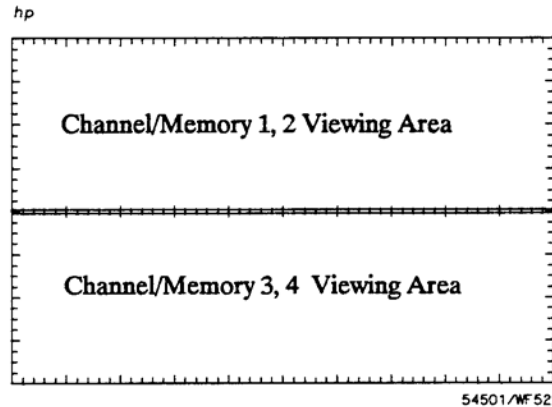

*Figure 7-2. Dual Screen Display*

When waveform math functions or the dual timebase window are turned on they are displayed in the lower half of the screen and the channels are displayed in the top half.

hp

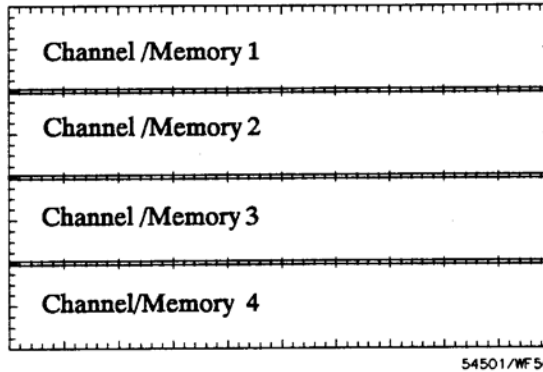

Figure 7-3. Quad Screen Display

---

## off/frame/ axes/grid Key

This unlabelled field selects one of four display backgrounds:

- **off:** The off option turns the background graticule off. The displayed waveform and waveform information is not turned off.
- **frame:** The frame option displays the outside border with a measurement scale. The measurement scale is incremented/decremented with major divisions and minor divisions based on the vertical and horizontal measurement settings.
- **axes:** The axes setting displays a background with the measurement scale crossing at mid-screen.
- **grid:** The grid background is a complete graticule with ten horizontal major divisions and eight vertical major divisions. Only the axis portion of the graticule has a minor division scale.

## connect dots Key

Connect-the-dots is a technique used to display waveform with all data points connected. This makes viewing the waveforms easier because the signal is complete and has no breaks.

### Note

*Connect-the-dots does not interpolate data and generate data points. The HP 54503A connects data points linearly.*

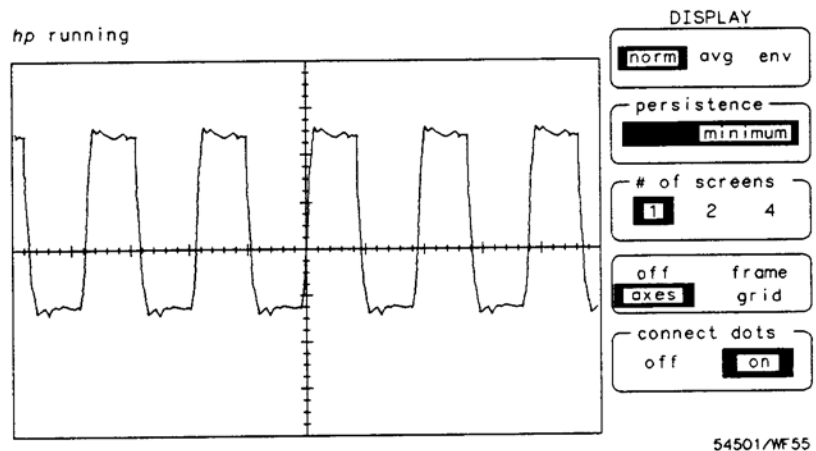

Figure 7-4. Connect-the-Dots



## Introduction to the Markers

This chapter describes how to use the markers and make manual measurements on displayed waveforms.

In this menu, two sets of markers are controlled. These markers are the  $\Delta V$  markers (horizontal voltage markers) and the  $\Delta t$  markers (vertical time markers). When the desired set of markers have been turned on and the two marker fields are turned on. The markers are controlled individually.

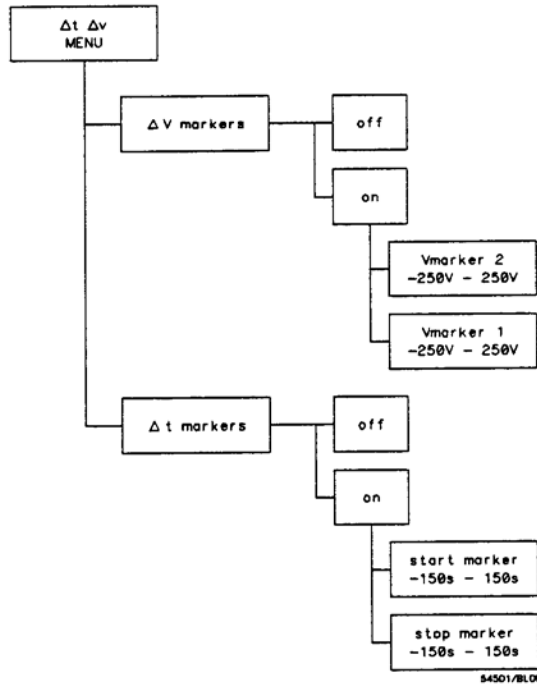
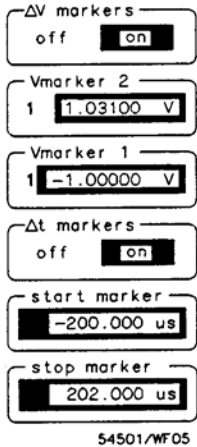
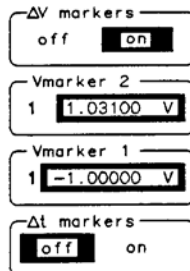

Figure 8-1. Delta t/Delta V Menu

---

## $\Delta V$ markers



54501/WF07

This function key toggles the markers on and off. With the  $\Delta V$  function turned on the next two fields are activated and the two markers are controlled individually.

When the  $\Delta V$  markers are turned on, *Vmarker2*, *Vmarker1*, and *delta V* appears in the factors display area. The delta V entry is calculated as the following:

$$\text{Vmarker 2} - \text{Vmarker 1} = \text{delta V}$$

If delta V is negative, Vmarker 1 is located at a more positive voltage level than Vmarker 2.

**Vmarker 2** This function key is a two function control field. The first function selects the desired channel, memory, or function to place Vmarker 2 for measurement. By pressing the function key again, the highlighted field moves to the numeric display to select the voltage level. Typically, place Vmarker 2 at the desired level on the waveform display and read the level, both in the highlighted field, and in the factors area of the waveform display.

Vmarker 2 is the voltage marker with shorter dashes.

**Vmarker 1** Vmarker 1 operation is identical to Vmarker 2, except it is represented by longer dashes.

## $\Delta t$ markers

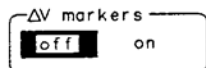

This function key toggles the time markers on and off. With the  $\Delta t$  function turned on the next two fields are activated and the two markers are controlled individually

The markers are placed on the display respective of the trigger point. Positive time values are to the right of the trigger point and negative time values are to the left. Delta t values are determined by the following:

$$\text{stop marker} - \text{start marker} = \text{delta t}$$

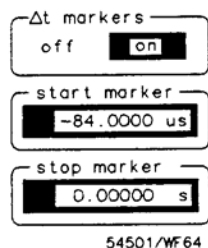

There is no such thing as negative delta t, this only means that the start marker is placed later in time than the stop marker.

$1/\text{delta t}$  is the inverse of delta t. Since the inverse of time is frequency, this ratio produces an answer in frequency, however, be alerted that if the markers are placed across parts of a waveform of differing time frames the answer may not be valid. This feature is useful when looking for the frequency in a burst that is different from the rest of the waveform. Place the time markers across the burst (at similar points on the waveform) and determine the frequency of the burst.

**start marker** To set the start marker press the function function key to highlight the field. This makes the start marker field active. Set the marker using the knob.

The start marker is represented with long dashes.

**stop marker** The stop marker is identical to the start marker, except that it is represented by short dashes.



## Introduction to the Functions

The **WAVEFORM MATH** menu defines one and/or two functions. The functions are used on data that is displayed on screen from any of the four channels or from any of the four waveform memories.

A function is generated by mathematically manipulating one or two operands with known operations. The HP 54503A uses these mathematical operations:

- plus (+)
- minus (-)
- times (x)
- versus (vs)
- only
- invert

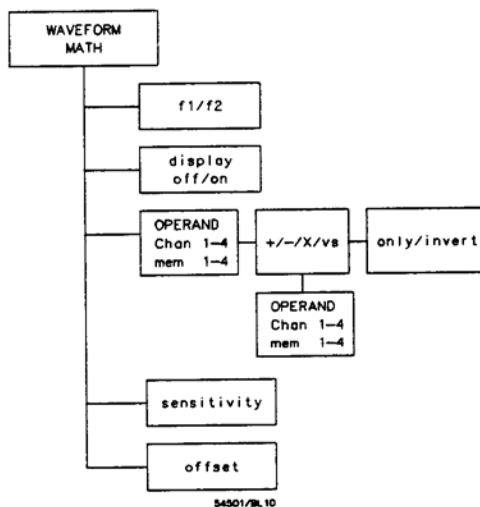

Figure 9-1. Waveform Math Menu

The vertical display and offset can be adjusted to place the function for best viewing.

When the function is calculated, it can be used in the following manner:

- displayed
- evaluated with the measurement features
- stored in memory
- output over the HP-IB

---

## Defining a Function

The WAVEFORM MATH menu selects and presets any of various operations, sources, and displayed results.

WAVEFORM MATH

f1	f2
----	----

display

off	on
-----	----

chan	1	2	3	4
mem	1	2	3	4

+	-	x	vs
only		invert	

chan	1	2	3	4
mem	1	2	3	4

sensitivity

1.00	V/div
------	-------

offset

1.00	V
------	---

54501/WF65

**Function Key** This key selects either function 1 or function 2.

**display Key** The display key turns the selected function on or off. The vertical sensitivity and offset are displayed in the function menu fields.

If the function display is turned on the screen will split with the original waveforms displayed in the top half screen while the functions are displayed in the bottom half screen. Both functions can be on at the same time and are displayed superimposed or in two screens in the bottom half of the CRT if multiple screens have been selected.

The timebase window is automatically turned off when a function is turned on.

**chan/mem Key** Press this key to select the first operand of the mathematical operation, or the waveform to be manipulated. The choice can be any displayed channel or any waveform memory that has a waveform stored. Ensure that the source is turned on.

If the operator is only or invert, it is the only operand that can be selected.

**Operator Key** This key selects any of the six functions. Continue pressing the function key until the operation desired is highlighted:

- **plus (+):** The two selected operands are added together in this function. Addition is calculated on a point-by-point basis.
- **minus (-):** The minus operation subtracts the second operand from the first.
- **times (x):** The times operation multiplies the value of the first operand with the value of the second operand. Each data point is multiplied with a corresponding data point and the product is placed on the function display. The displayed waveform will usually be scaled to correspond to a different sized waveform.
- **vs (versus):** The versus function draws a volts versus volts display of the two selected operands. Versus cannot be stored in a waveform memory because measurements cannot be made on the resultant waveform, however, it can be stored in pixel memory.

- **only:** The only function displays the first operand and scales it.
- **invert:** The invert function inverts the data of the first operand.

**chan/mem Key** This key selects the second operand, or the waveform that is manipulated against the first operand. The source choices are any of the displayed channels or any of the memories.

This key is not available if the operator is **only** or **invert**.

**sensitivity Key** The vertical sensitivity of the function is set with this key. This setting is for ease of viewing and making measurements with the newly developed waveform.

**offset Key** The offset of the function is set with this key.

---

## Vertical Scaling Units

The fundamental measuring units of an oscilloscope are volts/division in the vertical axis and time/division on the horizontal axis. This philosophy is used regardless of the mathematical function chosen. No provisions have been made to manage units for all combinations of operands and operations.

For example, apply a +2V signal to channel 1 and a -3V signal to channel 2. The HP 54503A displays the product as -6V, when in reality it is  $-6V^2$ .

---

## Displaying Functions

The HP 54503A has several screen variations available to accommodate a 4 channel display, as well as two functions.

---

In the single screen mode with a function on, the mathematical results are displayed in the bottom half of the screen while the operands are superimposed in the top half of the screen.

hp

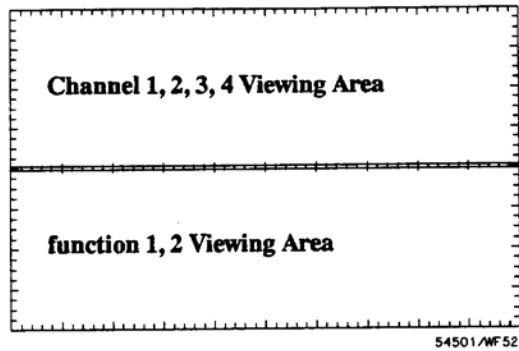

*Figure 9-2. Single Screen w/Function On*

- In the dual screen mode the functions are again displayed in the bottom half of the screen, however, the dual screens are displayed in the top half.

hp

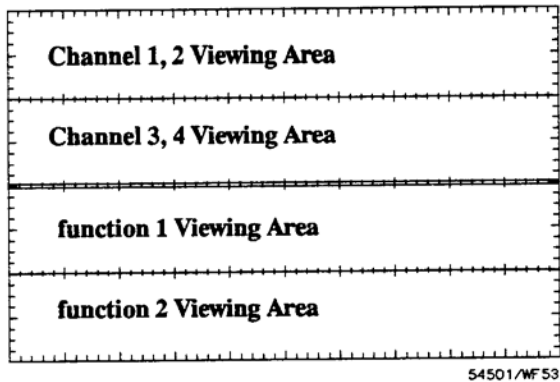

*Figure 9-3. Dual Screen w/Function On*

- In the quad screen mode, all four screens are displayed in the top half of the display while the functions are displayed in the bottom half.

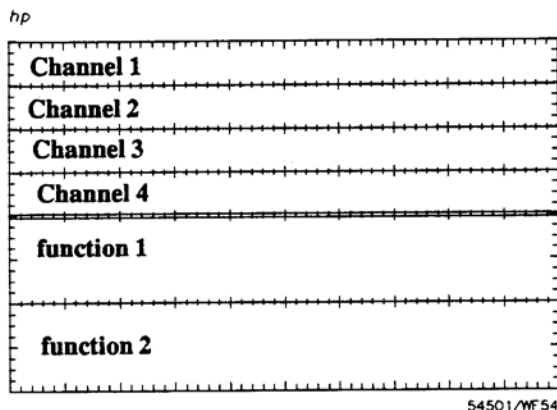

*Figure 9-4. Quad Screen w/Function On*

---

## Waveform Math Exercise

In this exercise you will use the Waveform Math menu to subtract one waveform from another.

**Instrument Setup** Set up an HP 8116A, or a signal generator capable of a 1 MHz, 1 volt squarewave, as follows:

- MODE = NORM
- FRQ = 1 MHz
- DTY = 50%
- AMP = 1.00 V
- OFS = 0.00 V
- Pulse = squarewave

Connect the signal to a BNC tee on channel 1 using a 1 meter coaxial cable. Connect another 1 meter cable from the other side of the BNC tee and terminate in 50  $\Omega$  to channel 4.

**Oscilloscope Setup** The extra cable length between channels 1 and 4 provides a time delay between the signals on the oscilloscope. The propagation of a 1 meter coaxial cable is approximately 6 to 7 ns. This delay is used to demonstrate the math function.

The following procedure will assist you in setting up the HP 54503A for optimal viewing.

- Press AUTOSCALE.
- Press DISPLAY to set the best viewing conditions. Set display mode to *avg*, # of *avg* to 8, # of *screens* to 2.
- Press WFORM MATH to define the function. Select **f1** and turn the display on. Select **chan 1**, - (minus), **chan 4** and set the function sensitivity to 2.00 V/div.

Now you can see the function of subtracting channel 4 from channel 1. The propagation between channels has allowed a 6 to 7 ns spike. To better view the results:

- Press TIMEBASE and set the horizontal display to 50.0 ns/div (see Figure 9-5).

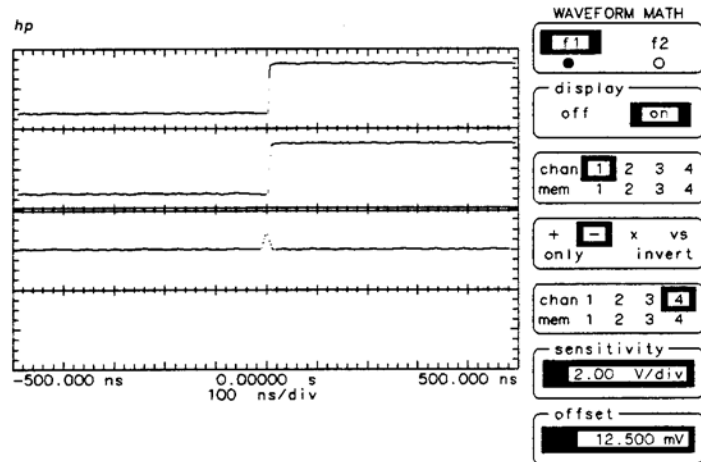

Figure 9-5. Channel 1 minus Channel 4

10 - Waveform Save Menu

## Introduction to the Memories

This chapter describes how to select the waveform and pixel memories on the HP 54503A. The menu consists of two submenus:

- waveform memories m1 - m4 are non-volatile memories used to store one waveform at a time.
- pixel memories p1 and p2 are volatile memories used for screen store. In this manner the memories are used as a storage oscilloscope.

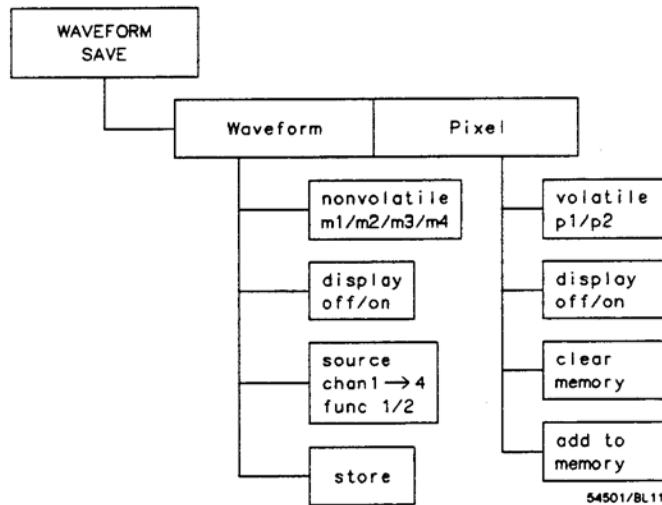
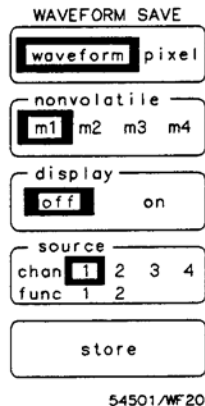

Figure 10-1. Waveform Save Menu

## waveform/pixel Key

This is the selection key used to choose the desired type of memory. The active menu is highlighted. Each memory type, waveform or pixel, has a separate menu. When this key is pressed, the rest of the menu changes.

## waveform Menu



The waveform menu has four available memories, m1, m2, m3, and m4. These memories are nonvolatile and are not cleared during AUTOSCALE, RECALL CLEAR, or recycling power. This permits disconnection of power and transportation of the oscilloscope without losing the contents of waveform memories.

A waveform memory consists of a single waveform record, including the horizontal and vertical scaling parameters. This allows measurements on stored waveform and function data. Voltage and time markers can be set on waveforms when they are displayed.

When the HP 54503A is in the envelope display mode and a waveform store is executed, the min value and max value are stored separately. The min value will be stored in m1 if m1 or m3 are the selected store locations, or m2 if m2 or m4 are the storage locations. The max values are stored in m3 or m4 respectively. A store message is displayed above the waveform display area informing you of the storage locations of both values.

**nonvolatile Key** This key selects which memory to use. The selections are nonvolatile memories m1, m2, m3 and m4. When a memory is turned on the small circle below the label is highlighted.

The waveform memories are record memories that store 2001 points of waveform information in each memory.

**display Key** This key toggles the selected memory display on or off.

**source Key** The source key selects the source waveform to be stored. The source alternatives are any channel or either function.

**store Key** This is the active key in the menu. This key stores the specified waveform in the specified memory. When the key is pressed, an immediate erase of the selected memory and a write to the memory is executed.

## pixel Menu

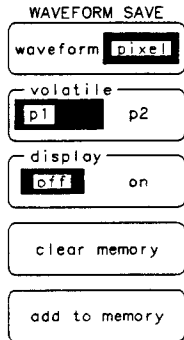

54501/WF19

The pixel submenu selects the pixel memories. These memories are very useful when additive memory capabilities are needed. Waveforms can be stored and added to indefinitely.

 **ARTEK MEDIA**  
Signature Not Verified

Digitally signed by ARTEK MEDIA  
DN: cn=ARTEK MEDIA, o=DC  
Henderson, c=US  
Date: 2005.05.16 05:25:00 -06'00'

**volatile Key** This is the memory select key. The alternatives are pixel memory 1 or 2. The pixel memories are complete pixel saves of the waveform area (excluding the graticule and markers) in volatile memory. The waveform display area is 256 X 451 pixels.

In pixel memory the entire screen is saved, therefore, data is mapped directly onto the display and displayed in halfbright. There are no measurement capabilities on pixel memories.

Pixel memories are additive. When all pixels are full, add to memory will merely overwrite existing data.

**display Key** This key toggles the selected pixel memories on or off.

**clear memory Key** This key purges all data from the selected pixel memory.

**add to memory Key** By pressing this key, the currently displayed waveforms are added to the specified pixel memory.

---

## Waveform Save Exercise

This exercise demonstrates how to store a waveform, changes the offset setting, and recalls the stored waveform to be compared with the current display.

**Instrument Setup** Set up an HP 8116A or a signal generator capable of a 6 kHz, 1 volt squarewave:

- Mode = NORM
- FRQ = 6.00 kHz
- DTY = 50%
- AMP = 1.00 V
- OFS = 0.00 V
- Pulse = squarewave

**Oscilloscope Setup** This procedure assists in setting up the HP 54503A for optimal viewing.

- Connect this signal to the Channel 1 input.
- Press AUTOSCALE.
- Press WFORM SAVE and select the **waveform** submenu.
- Press the **nonvolatile** key until **m3** is selected.
- Press the **source** key until **chan 1** is selected.

- Press the **store** key.

The currently displayed waveform is in nonvolatile memory m3. The remainder of this exercise demonstrates how to recall the stored waveform.

- Press the **display** key to turn on the **m3** display.
- Press the **CHAN** menu key, change the **offset** of channel 1.

This moves the current display so the stored waveform can be viewed. The display should look like the following figure.

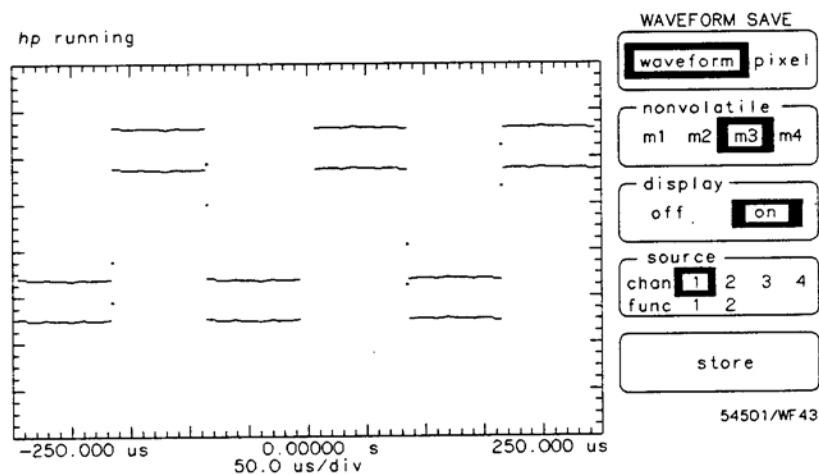

*Figure 10-2. Displayed Memory*

11 - Define Measure Menu

## Introduction to Measurements

This chapter contains a description of how to use the measurement menu. This is a very powerful and encompassing feature. Press the front panel key DEFINE MEAS to access the entire measurement function.

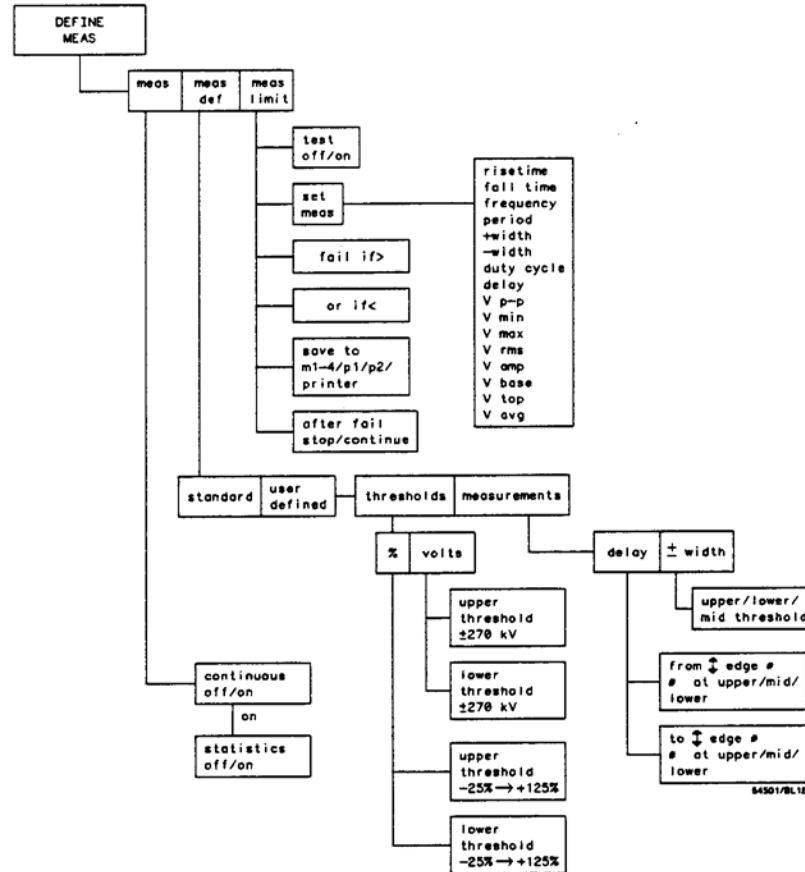

Figure 11-1. Define Measure Menu

The first menu sets the dynamic controls for the measurement. The second sets user-defined parameters for the measurements. And the third sets up the measurement comparison test.

---

## Measurement Selection

Each key in the numeric keypad section has a secondary function. Above each key is a measurement selection printed in blue. To make an immediate measurement of the displayed waveform perform the following keystrokes:

- Press the blue (Shift) key on the numeric keypad to access the secondary keys.
- Press the key that corresponds to the measurement.
- Rotate the knob to select the measurement source (channel number, **c#**; memory number, **m#**; or function number, **f#**). The choice is displayed below the waveform display area.
- Press the appropriate number to select the source, channels 1-4, memories 1-4, or functions 1-2.

To make a selected measurement on a waveform source, it must be turned on. Upon selection of the measurement the time and voltage markers are placed on the waveform to show where the measurement was made if continuous measurements are off.

To clear measurements, press Shift and then CLR MEAS.

For complete details of the measurement definitions and algorithms, see Appendix A, "Algorithms."

---

## meas/meas def/meas limit Key

This key is the primary sub-menu function key. Press to select one of the available sub-menus. This field is always the top selection so other submenus can be selected at any time.

---

## meas Submenu

The measure submenu is the default condition. The continuous and statistics options can also be accessed.

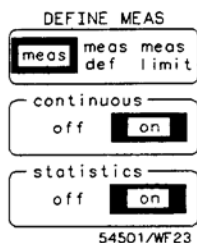

**continuous Key** If this option is turned on when a measurement selection is made, the displayed measurement is updated periodically. All subsequent measurements are continuously updated as they are selected.

When **continuous** is off, the measurement is made once and the  $\Delta t/\Delta V$  markers are placed on that measurement showing where the measurement was made.

**statistics Key** The continuous function must be on before the statistics key is available. When **continuous** is on, statistics display the **min value**, **max value**, **average value**, and **current value** of up to three measurements.

## Measure Define Submenu

The measure define submenu selects measurement standards assigned by the user. This gives the option of making measurements based on signal width or delay settings or threshold parameters.

### standard/user defined Key

If **standard** is selected, no other choices are available and the HP 54503A will make measurements based on the IEEE standards for the particular measurement.

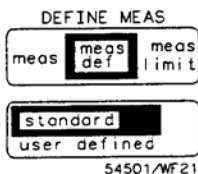

If, however, **user defined** is selected, two sets of test conditions are available to define the measurements.

### thresholds/measurements Key

This key sets the vertical test conditions, voltage or percentage ratios, independent of the horizontal test conditions, edge, slope, and count. Both sets of test conditions must be set to define the measurement.

The **thresholds** submenu sets the vertical test conditions at:

- percentage ratio from -25% to 125%
- voltage levels from -250 kV to +250 kV

#### Note

*The upper and lower thresholds must be set to levels that will fall on the displayed waveform. If either threshold is not on the waveform the measurement results will be the message 'not found.'*

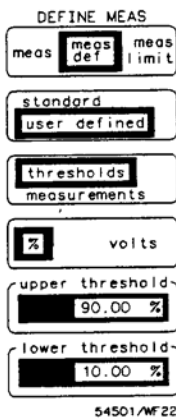

Threshold settings apply to all user defined front panel measurements.

This feature is useful when measuring for excessive overshoot or ringing. By defining the measurements, testing for specific pass/fail criteria from the front panel, or set the HP 54503A in the limit test and allow the oscilloscope to report without supervision.

### Note

*If the user defined upper and lower thresholds are placed too close together it is possible the HP 54503A will not be able to determine the mid-point. The message 'not found' will be displayed in the measurement factors area.*

Measurements defines more parameters, the horizontal test conditions, for three specific front panel keypad measurements:

- delay
- + width
- - width

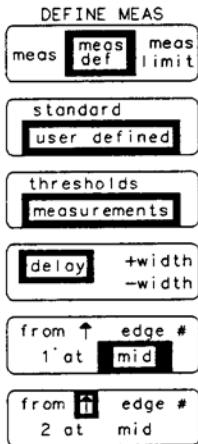

54501/WF67

When any of the three measurements are selected the measurement is made on the selected edge count, slope, and transition point. The HP 54503A starts counting edges from the left edge of the screen, not at the reference point. The selected edge must be displayed. If the edge is not displayed, the message not found is displayed in the measurement results area below the screen.

Measurement delay, not to be confused with timebase delay (see Chapter 4, 'Timebase Menu') is useful when measuring source-to-source delays or measuring time separation on the same source or a different source. The front panel delay measurement can be redefined by edge slope, edge count (from 1 to 100), and what part of the transition edge (upper, lower, mid) is used as a reference point.

- When setting edge count fields, it is handy to press the **fine** key. In the course mode the HP 54503A increments/decrements by tens (1, 11, 21,...100). In the fine mode the increment/decrement sequence is in 1's.

When the delay measurement is selected from the front panel, the sources (**c#**, **f#**, **m#**) and the source number must be selected next.

**+ width** chooses only the point on the waveform transition (upper, lower, mid) to measure when making the positive width of a displayed waveform.

**- width** chooses only the point on the waveform transition (upper, lower, mid) to measure when making the negative width of a displayed waveform.

## Measure Limit Sub-menu

DEFINE MEAS

meas	meas	meas
def	limit	

test

off	on
-----	----

set

period
--------

fail if >

50.0000 s
-----------

or if <

1.000 ns
----------

save to

off	m1	m2	m3	m4
p1	p2	printer		

after save

stop	continue
------	----------

54501/WF24

The HP 54503A can run limit tests on up to three measurements. The menu presets certain conditions and stores any failure data for evaluation at a later time. Set the limit test while in this menu and select the measurement from the front panel.

When a test is running, statistical data is displayed describing the test:

- current measurement
- minimum value
- maximum value
- average value

Failure data, as well as information regarding memory and save data is displayed.

### Note

*At least one measurement and up to three measurements must be selected from the keypad. The limit test will be run on front panel measurements.*

**test Key** This switch toggles the test routine on and off. When the test is turned on the oscilloscope runs in the test mode on the most current measurements that are selected.

**set Key** This key selects the measurement. There are sixteen measurements available; the same ones as are available on the numeric keypad.

- Press the function key to highlight the field and rotate the knob to select the desired measurement.

**fail if > Key** This field sets the upper failure threshold. The range on this field is dependent upon the units of the desired measurement.

**or if < Key** This key sets the lower threshold of the failure parameters.

**save to Key** The data associated with the failure can be saved to memories or to a hardcopy device. The channel that is saved is selected in the WAVEFORM SAVE menu.

- In the case of saving to nonvolatile memory, one memory may be selected. If multiple failures occur, only the last failure data will be saved because the most current data will overwrite the memory contents.
- If the data is saved to pixel memory, an accumulated save occurs. No measurements may be made on the pixel data.
- A save to a printer immediately sends the data to the peripheral device.
- The **save to** key can be turned off and no save will be effected.

**after fail Key** The test can be stopped after a failure occurs, or continue the test.



## Introduction to the Utilities



The **UTILITY** menu accesses the calibration and service functions, as well as sets up the HP-IB interface. The submenus include self-test, calibration, service and a listing for the current firmware revision date.

This menu controls all of the service functions that maintain the reliable performance of the oscilloscope:

- HP-IB menu
- Selftest menu
- Probe cal menu
- Self cal menu
- Service menu
- Clicker control
- AC BNC

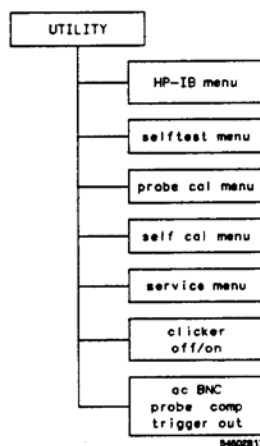

Figure 12-1. Utility Menu

## HP-IB menu

The HP-IB submenu makes settings so the HP 54503A can talk to peripheral devices. This interface includes two primary settings:

- talk only mode
- addressed mode

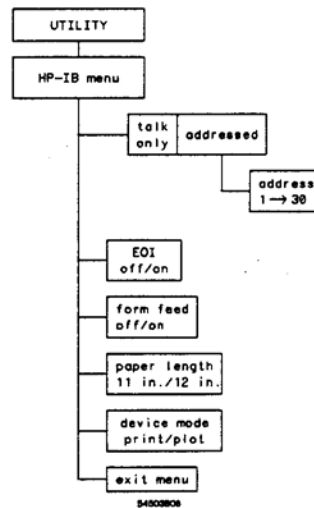
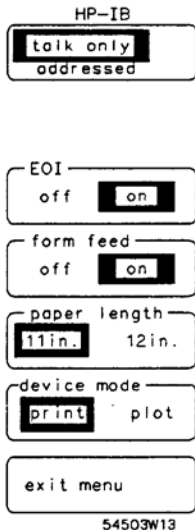

Figure 12-2. HP-IB Menu

**talk only mode** Set the oscilloscope to **talk only** to perform a hardcopy without intervention from an external controller. The attached printer must be set in the **listen only** or **listen always** mode.

**addressed mode** This mode allows a controlling device to selectively address the HP 54503A for talking or listening. The address of the HP 54503A can be selected while the instrument is in the addressed mode.

The range of available addresses is 0-30

**EOI Key** The EOI (End or Identify) key toggles this function on or off. EOI is a line on the HP-IB asserted with the last data byte of a message. If this function is on, EOI is asserted by the HP 54503A on the last byte of each message sent. If it is off, EOI is not asserted.

This function only affects messages sent from the HP 54503A. The HP-IB accepts any of the legal IEEE 488.2 message terminators regardless of the setting of this function.

#### **Note**

*IEEE 488.2 requires that EOI is asserted. Therefore, with EOI off, the HP 54503A will send messages that do not follow IEEE 488.2 rules concerning EOI. EOI should only be turned off if the controller does not deal with EOI appropriately.*

**form feed Key** If the form feed option is on, the printer performs a form feed at the end of the hardcopy. If form feed is off, the page is scrolled up four lines when the hardcopy is complete.

**paper length Key** Select between 11-inch or 12-inch pagelengths for auto form feed. This is used to set the 11-inch page, the U.S. standard, or the 12-inch page, U.K. and European standard.

**device mode Key** This key selects whether the hardcopy goes to a printer or plotter. The HP 5503A has been designed to send hardcopy to HP printers and plotters with HP-IB options.

The following printers have been successfully tested with the HP 54503A: HP 2225A HP-IB ThinkJet, HP 2227B QuietJet, and HP 3630A Option 002 PaintJet.

The following plotters have been successfully tested with the HP 54503A: HP 7440A Color Pro, HP 7470A Option 002, HP 7475A Option 002, HP 7550A and HP 9872C.

**exit menu Key** Pressing this key returns the **UTILITY** menu to the screen..



If the HP 54503A fails any selftest perform the following:

- Recalibrate the oscilloscope.
- If that does not fix the problem, refer to the *HP 54502 Service manual*.

The HP 54503A self-diagnostics and self-tests are designed to run operational tests on the following:

- RAM
- ROM
- Acquisition
- Miscellaneous

The image shows a terminal window with the following content:

```
SELFTEST MENU
ram  rom  acq
misc  loop

display  acq
system  nonvol

start test

test all

exit menu
```

Below the menu, the test results are listed:

```
PASSED System RAM
PASSED Non-Volatile RAM
PASSED Display RAM
PASSED Protected Non-Volatile RAM
PASSED System ROM
PASSED Acquisition RAM
PASSED Logic Trigger
PASSED Timebase
PASSED D/A Converter
PASSED HPIB
PASSED A/D Converter
```

A box highlights the instruction: **to run selftest, disconnect all inputs**

At the bottom right, the text **54501W75** is visible.

*Figure 12-4. Results of Selftest*

**ram Test** The RAM test is a multiple selection field with the following options:

- display
- acquisition
- system
- unprotected nonvolatile memory

**rom Test** Two ROM tests are available:

- system
- protected nonvolatile memory

**acquisition Test** Four acquisition tests are available:

- logic trigger
- A/D
- timebase
- D/A

**Miscellaneous Test** Three miscellaneous tests are available:

- HP-IB
- keyboard
- CRT

**loop Test** The loop test is a function designed for use by qualified service personnel. It is unnecessary to use this function for normal oscilloscope operation. When a self-test loop has been initiated it runs until stopped by pressing and holding any key.

**start test Key** Pressing this key begins the selected test.

**exit menu Key** Pressing this key returns the Utility menu to the screen.

## probe cal menu

Two probe calibration procedures are available in the **PROBE CAL MENU**:

- Attenuation
- Time null

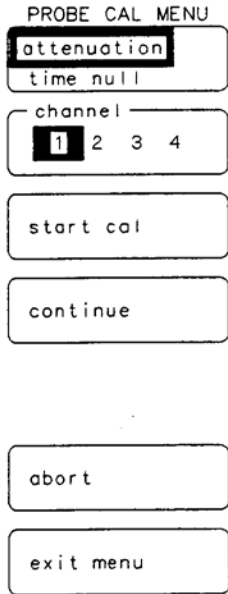

54503B09

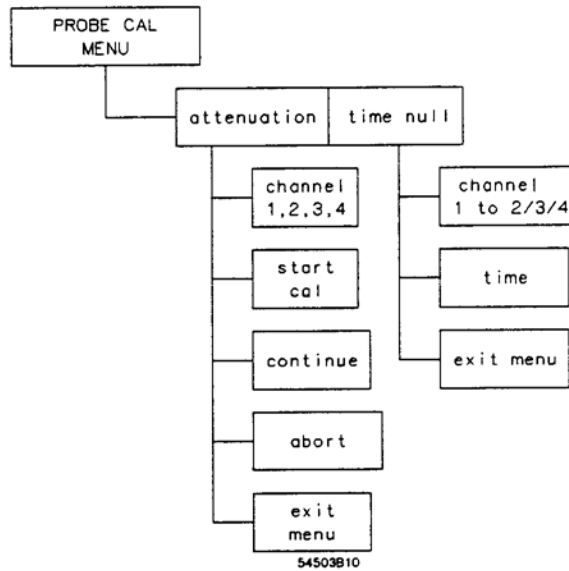

Figure 12-5. Probe Cal Menu

**attenuation submenu** The attenuation submenu calibrates channel gain at the probe tip. Channel gain can be corrected through probe attenuation down to 0.9 attenuation.

- Below 0.9 the error message **Attenuation less than 1**, see manual for action is displayed. The corrective action is to recalibrate the HP54503A.

If the probe is not connected to the DC CALIBRATOR OUTPUT on the rear panel or the probe attenuation exceeds approximately 250, the error message **Attenuation too high or bad connection** is displayed. The corrective action is to check the connections and recalibrate. If recalibration is unsuccessful, refer to the *HP 54503A Service* manual.

- If the probe attenuation calibration is successful the displayed message is **Probe Attenuation = n.nnnnn** This value has been entered into your channel probe setting.

**channel Key** Pressing this key selects a channel to calibrate. By continually pressing the key, the fields are incremented by channel.

**start cal Key** When the channel to be calibrated has been selected, press **start cal**. The advisory appears at the bottom of the waveform display area **Connect the DC Cal rear panel bnc to the probe of channel n, then press continue**. Pressing this key prompts for setup requirements.

**continue Key** Press this key when all setup requirements have been satisfied. The actual calibration process begins.

**abort Key** This is the only active front panel key during the calibration process. If you press this key, the calibration process is terminated with the previous calibration factors intact.

**exit menu Key** Pressing this key returns the **UTILITY** menu to the screen.

### time null submenu

Time null sets the timing of all channels to correspond to each other. This eliminates any time discrepancies between channels and guarantees that channel to channel skew variations are non-existent. This is useful to manually adjust any differences in cable length.

PROBE CAL MENU

attenuation
time null

channel
1 to 2

0.00000 S
-----------

exit menu
-----------

54503B11

**time Key** This is an unlabelled field. The time null between the two channels can be set using either of the entry devices. The range is  $\pm 70$  ns.

**exit menu Key** Pressing this key returns the UTILITY menu to the screen.

---

## Self Cal menu

The self cal menu calibrates two internal functions:

- vertical cal
- delay cal

**cal select Key** This field selects which of the calibration processes to perform. Press the cal select key and the highlighted window increments through 0-1 and the active field in the display changes to correspond with the selection.

**channel Key** The channel key selects the channel to calibrate.

**start cal Key** When the channel to calibrate is selected, and the specific cal routine is selected, press the **start cal** key and follow the instructions displayed.

**continue Key** When all of the setup requirements are satisfied, press the **continue** key and the actual calibration process begins.

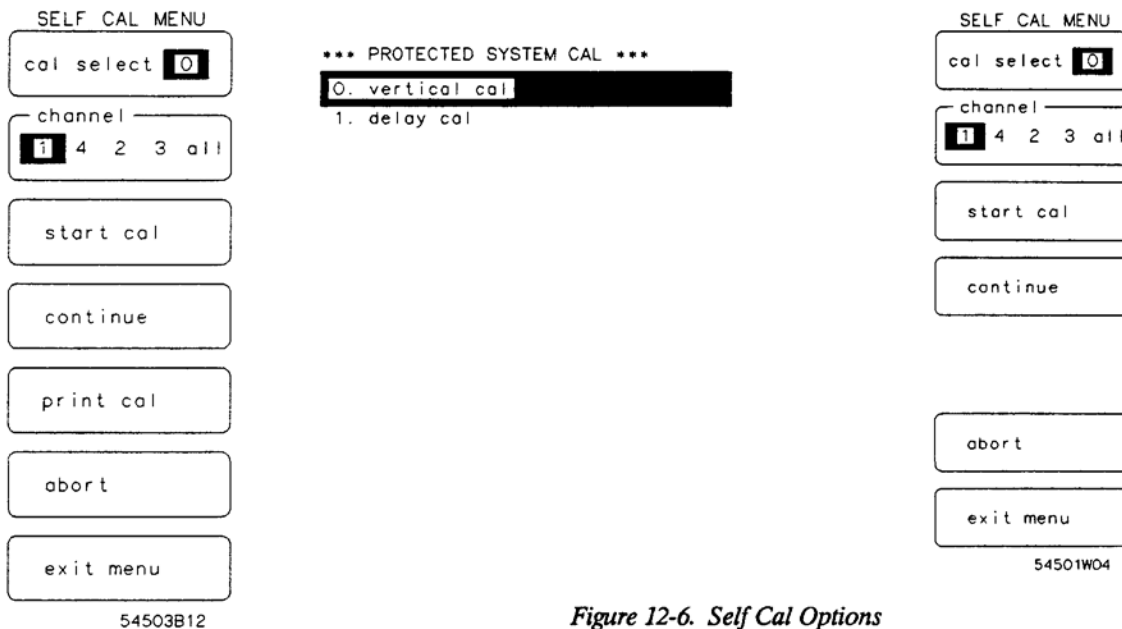

*Figure 12-6. Self Cal Options*

**abort Key** This is the only active front panel key during the calibration process. Pressing this key terminates the calibration process leaving the previous calibration factors intact.

**exit menu Key** This key returns to the UTILITY menu.

**Note**

*Cal 0 must pass before Cal 1 can be performed successfully.*

---

## service menu

The service menu is used for firmware calibrations, hardware adjustments and calibrations that need not be performed often. These are explained in the service manual and are to be used only by qualified service personnel.

### Note

*When certain calibrations have been performed, other calibrations must be continued. Only qualified service personnel, with access to the service manual, are to perform calibrations in the service manual.*

See the *HP 54503A Service Manual* for complete information on the service menu and calibration cycles.

---

## clicker Key

The clicker key turns on the clicker function. When the clicker is turned on, an audible click is heard each time a key is pressed. The selections are either on or off.

---

## Calibration Procedure

There are two levels of calibration for the HP 54503A. The first level is in the self cal menu and suggested by HP to be performed under the following conditions:

- at six month intervals or every 1000 hours of use,
- if the ambient temperature changes more than 10 ° C from the temperature at full calibration,
- or, the user would like to optimize measurement accuracy.

Self cals do not require equipment other than cables. It is necessary to UNPROTECT the calibration. Follow the Self Cal Menu calibration procedures to perform this first level of self cal.

The second level of self calibrations are to be performed only by qualified service personnel with access to the service manual.

### Note

*Before the HP 54503A can be calibrated the CALIBRATION toggle switch on the rear panel must be set to UNPROTECTED.*

The procedure for calibration is:

- Set the rear panel CALIBRATION switch to UNPROTECTED.
- Enter the self cal menu.
- Select 0 in the cal select field and calibrate the vertical factors. This routine calibrates the A/D, vertical gain, offset, and trigger with the rear panel calibrator signal..
- Select 1 in the cal select field and calibrate the delay.

When the software calibrations are complete reset the CALIBRATION switch on the rear panel to PROTECTED.

**Appendixes**

---

One of the primary features of the HP 54503A is the ability to make automatic measurements on displayed waveforms. This chapter provides details on how automatic measurements are calculated and some tips on how to improve results.

---

## Measurement Setup

Measurements typically should be made at the fastest possible sweep speed for the most accurate measurement results. The entire portion of the waveform that is to be measured must be displayed on the oscilloscope. That is:

- at least one complete cycle must be displayed for period or frequency measurements
- the entire pulse must be displayed for width measurements
- the leading edge of the waveform must be displayed for risetime measurements
- the trailing edge of the waveform must be displayed for falltime measurements

---

## Making Measurements

If more than one waveform, edge, or pulse is displayed, the measurements are made on the first (leftmost) portion of the displayed waveform that can be used. If there are not enough data points the oscilloscope will display  $\leq$  with the measurement results. This is to remind you that the results may not be as accurate as possible. It is recommended that you re-scale the displayed waveform and make your measurement again.

**Standard Measurements**

When any of the standard measurements are requested, the HP 54503A first determines the top-base voltage levels at 100%-0%. From this information, it can determine thresholds (10%, 90%, and 50%) needed to make the measurements. The 10% and 90% thresholds are used in the risetime and falltime measurements. The 50% mid-point is used for measuring frequency, period, pulse width, and duty cycle.

The voltage thresholds are precise settings and sets specific locations on the waveform. If the thresholds are not placed on the waveform (above or below) the HP 54503A cannot make a measurement.

**User defined Measurements**

When any of the user defined measurements are requested, the HP 54503A still must determine the top-base voltage thresholds. From this information it can determine user defined upper and lower thresholds. The mid-point is then determined to be the 50% point between the upper and lower threshold.

---

**Automatic Top-Base**

Top-Base is the heart of most automatic measurements. It is used to determine  $V_{top}$  and  $V_{base}$ , the 0% and 100% voltage levels at the top and the bottom of the waveform. From this information the oscilloscope can determine the 10%, 50%, and 90% points, which are also used in most measurements. The top or base of the waveform is not necessarily the maximum or minimum voltage present on the waveform. Consider a pulse that has slight overshoot. It would be wrong to select the highest point of the waveform as the top since the waveform normally rests below the perturbation.

Top-Base performs a histogram on the waveform and finds the most prevalent point above and below the waveform midpoint. The most prevalent point is one that represents greater than approximately 5% of the total display points (501) and is considered to be either the top or base. If no point accounts for more than 5% of the total, then the top is chosen as the absolute maximum and the base is chosen as the absolute minimum.

---

## Edge Definition

Both rising and falling edges are defined as transitional edges that must cross three thresholds.

A rising edge must cross the lower threshold in a positive direction (defining it as a rising edge), cross the mid threshold (any number of crossings, both positive and negative are permissible) and then cross the upper threshold without any crossing of the lower threshold.

A falling edge must cross the upper threshold in a negative direction, cross the mid threshold (any number of times), and then cross the lower threshold without crossing the upper threshold.

### Note

*Most time measurements are made based on the position of the first crossing of the middle threshold.*

---

## Algorithm Definitions

Following are the definitions that all measurements are based on:

**delay** There are three types of delay measurement:

- jitter
- standard
- user-defined

Jitter occurs only under the following circumstances:

- standard/user-defined key is set to standard
- two delay parameters are the same
- display mode is envelope

if

**first edge on minimum waveform is rising**

**then**

**delay = mid-threshold of first rising edge of max waveform minus  
mid-threshold of first rising edge on min waveform**

**else**

**delay = mid-threshold of first falling edge on min waveform  
minus mid-threshold of first falling edge on max waveform**

The standard delay measurement occurs when in the standard mode (not user-defined) and is not a jitter measurement.

**standard delay = mid-threshold of the first edge of second  
parameter minus mid-threshold of the first edge of the first  
parameter**

**Note**

*Negative delay is possible*

**User defined delay = second channel edge minus first channel  
edge**

**+ width** The + width algorithm has standard and user-defined considerations.

**if**

**first edge is rising**

**then**

**+ width = mid-threshold crossing of first falling edge -  
mid-threshold crossing of first rising edge**

**else**

**+ width = mid-threshold crossing of second falling edge -  
mid-threshold crossing of first rising edge**

User-defined is the same as Standard definition except user-defined threshold.

**- width** The - width algorithm has standard and user-defined considerations:

**if**  
     **first edge is rising**  
  
**then**  
     - width = second rising edge - first falling edge  
  
**else**  
     - width = first rising edge - first falling edge  
  
**Period**      **if**  
                 **first edge is rising**  
  
**then**  
     period = second rising edge - first rising edge  
  
**Frequency**      frequency = 1/period  
  
**Duty Cycle**      duty cycle = (+ width/period) \* 100

**Note**

+ width is always calculated using mid-threshold.

**Risetime**      risetime = time at upper threshold - time at lower threshold

**Falltime**      falltime = time at lower threshold - time at upper threshold

**V<sub>max</sub>**      V<sub>max</sub> = voltage of the maximum point on screen

**V<sub>min</sub>**      V<sub>min</sub> = voltage of the minimum point on screen

**V<sub>p-p</sub>**      V<sub>p-p</sub> = V<sub>max</sub> - V<sub>min</sub>

**V<sub>top</sub>**      V<sub>top</sub> = most prevalent point above waveform midpoint

**V<sub>base</sub>**      V<sub>base</sub> = most prevalent point below waveform midpoint

**V<sub>amp</sub>**      V<sub>amp</sub> = V<sub>top</sub> - V<sub>base</sub>

**V<sub>avg</sub>** Average voltage of the first cycle of the displayed signal is measured. If a complete cycle is not present the oscilloscope will average all data points.

**V<sub>rms</sub>** The rms voltage of the first cycle of the displayed signal is measured. If a complete cycle is not present, the measurement will compute rms on all data points.

$$V_{rms} (ac) = \{ 1/n \sum_{j=1}^n V_j^2 - 1/n \sum_{j=1}^n V_j \}^{1/2}$$

## Specifications and Characteristics

---

### Specifications

The following are performance specifications for the HP 54503A Digitizing Oscilloscope.

#### Vertical

**Bandwidth**(-3dB, dc coupled)

**Repetitive:**<sup>1</sup> dc to 500 MHz

**Single-shot:** dc to 2 MHz (based on 10 points per period of input signal)

**Risetime:**<sup>2</sup> 700 ps

**Input R** (selectable): 1 M $\Omega$   $\pm$ 1% or 50  $\Omega$   $\pm$ 1%

**Maximum Input Voltage**<sup>3</sup>

1 M $\Omega$ :  $\pm$ 250 V [dc + peak ac (< 10 kHz)]

50 $\Omega$ : 5 V<sub>rms</sub>

**Offset Accuracy:**<sup>4</sup>  $\pm$ (0.5% of ch. offset + 2% of full scale)

**Voltage Measurement Accuracy (dc)** <sup>4,5</sup>

**Dual Cursor:**  $\pm$ (1.25% of full scale + 0.032  $\times$  V/div)

**Single Cursor:**  $\pm$ (1.25% of full scale + offset accuracy + 0.016  $\times$  V/div)

#### Horizontal

**Time Base Reference Accuracy:** 0.005%

**Delta-t Accuracy**

**Real-time:**  $\pm$ (2%  $\times$  s/div + 0.005%  $\times$  delta-t + 100 ps)

## Trigger      Trigger Sensitivity

≥5 mV/div

dc to 100 MHz: 0.063 × full scale

100 MHz to 500 MHz: 0.156 × full scale

< 5mV/div

dc to 100 MHz: 2.5 mV

100 MHz to 500 MHz: 6 mV

**NOTES:** Specifications valid for temperature range  $\pm 10^{\circ}\text{C}$  from software calibration temperature with eight or more averages selected.

1. Upper bandwidth reduces by 2.5 MHz for each  $^{\circ}\text{C}$  above  $35^{\circ}\text{C}$ .
2. Rise time figure is calculated from:  $t_r = 0.35/\text{Bandwidth}$ .
3. On ranges  $\leq 50$  mV/div the maximum overdrive of the input must not exceed 1000 times the V/div setting.
4. Expansion is used below 7 mV/div range so vertical resolution and accuracies are correspondingly reduced.
5. Accuracy decreases 0.08% per  $^{\circ}\text{C}$  from software calibration temperature.

---

## Characteristics

The following are performance characteristics of the HP 54503A Digitizing Oscilloscope.

### Vertical

#### Switchable Bandwidth Limits

ac-coupled (lower -3 dB frequency): 90 Hz

LF reject (lower -3 dB frequency): 450 Hz

bandwidth limit (upper -3dB frequency): dc to 30 MHz

Number of channels:<sup>1</sup> 4

Vertical Sensitivity Range (all channels): 1 mV/div to 5 V/div

Vertical Gain Accuracy (dc):<sup>2,3</sup>  $\pm 1.25\%$

Vertical Resolution:<sup>3</sup>  $\pm 0.4\%$  (8-bit A/D)  
 $\pm 0.1\%$  (10 bits via HP-IB with averaging)

Maximum Sample Rate: 20 MSa/s

**Waveform Record Length<sup>4</sup>**  
501 points (display)  
1024 points (via HP-IB)

**Input C:** 7 pF nominal

**Input coupling:** ac, dc

<b>Offset Range:</b>	<b>Vertical Sensitivity</b>	<b>Available Offset</b>
	1 mV - 50 mV/div	±2 V
	> 50 mV - 250 mV/div	±10 V
	> 250 mV - 1.25 V/div	±50 V
	> 1.25 V - 5 V/div	±250 V

**Dynamic range (dc + peak ac):**  $\pm 1.5 \times$  full scale from center of screen

**Channel-to-channel Isolation**

(with channels at equal sensitivity)      **40 dB:** dc to 100 MHz  
**30 dB:** 100 to 500 MHz

**NOTES:** Specifications valid for temperature range  $\pm 10^{\circ}\text{C}$  from software calibration temperature with eight or more averages selected and channel(s) in sensitivity range 1, 2, or 5.

1. Simultaneous acquisition on two channels. channels 1 and 4 are acquired simultaneously. If four channels are used, data is acquired alternately by channels 1 and 4, then 2 and 3.
2. Accuracy decreases 0.08% per  $^{\circ}\text{C}$  from software calibration temperature.
3. Expansion is used below 7 mV/div range so vertical resolution and accuracies are correspondingly reduced.
4. For single-shot via HP-IB, waveform record length is 500 points. In repetitive mode:
  - 200 ps/div time base range, waveform record length is 100 points
  - 500 ps/div time base range, waveform record length is 250 points
  - 1 ns/div time base range, waveform record length is 500 points
  - $\geq 2$  ns/div time base range, waveform record length is 1000 points

**Horizontal**    **Timebase Range:** 200 ps/div to 5 s/div

**Timebase Resolution:** 20 ps

	<u>Time/div Setting</u>	<u>Available Delay</u>
<b>Delay Range</b> (post-trigger)	50 ms - 5 s	40 × (s/div)
	100 μs - 20 ms	1 s
	200 ps - 50 μs	10,000 × (s/div)
<b>Delay Range</b> (pretrigger)	5 μs - 5 s	-39.96 × (s/div)
	10 ns - 2 μs	-99.9 μs
	200 ps - 5 ns	-10,000 × (s/div)

**Trigger**    **Trigger Pulse Width (minimum):** 1.5 ns

**Trigger Level Range:** ±1.5 × full scale from center of screen

---

## Operating Characteristics

**Vertical**    **Deflection Factors:** All channels: With single screen selected, attenuation factors are adjustable from 1 mV/div to 5 V/div in a 1-2-5 sequence with the knob. Finer adjustments can be made using direct keypad entry or the knob with the fine key selected.

**Probe Attenuation Factors:** Values from 0.9 to 1000 may be entered to scale the oscilloscope for external probes or attenuators attached to the channel inputs. When probe tip calibration is done, this value is calculated automatically.

**Input Impedance:** 1 MΩ or 50 Ω selectable for each input.

**Bandwidth limit (HF Reject):** Can be selected for each input individually. Provides low pass filter with a -3 dB point at approximately 30 MHz for both triggering and signal display.

**LF Reject:** Can be selected for each input individually. Provides high pass filter with a  $-3$  dB point at approximately 450 Hz for both triggering and signal display.

**AC Coupling:** Can be selected for each input individually. Provides high pass filter with a  $-3$  dB point at approximately 90 Hz and a two-pole rolloff for both triggering and signal display.

**ECL/TTL Presets:** Vertical deflection factor, offset, and trigger level can be preset independently on each channel for ECL and TTL levels.

**Horizontal Dual Timebase Windowing:** Allows user to zoom in on portions of the waveform using cursors that are displayed on the top half of the screen. An expanded timebase is displayed on the lower half of the screen. The window timebase can be set to provide as much as a 20:1 expansion ratio. Waveform measurements are performed on the dual timebase window information when windowing is turned on.

**Delay Between Channels:** Difference in delay between channels can be nulled out to compensate for differences in input cables or probe length. Use the "time null cal" found in the Utility menu.

**Reference Location:** The reference point can be located at the left edge, center, or right edge of the display. The reference point is equal to trigger point plus the delay time.

**Trigger Modes Edge Trigger:** Positive or negative edge can be selected for trigger on any of the four channel inputs.

**Pattern Trigger:** A pattern can be specified using all four of the inputs. Each of the inputs can be specified as a *high*, *low*, or *don't care* with respect to the level setting in the edge trigger menu. Trigger can be selected to occur on the last edge to enter the specified pattern or the first edge to exit the specified pattern.

**Time Qualified Pattern Trigger:** A trigger will occur on the first edge to exit a pattern only if it meets the specified time criteria. The available time qualified modes are:

- pattern present < [time]
- pattern present > [time]
- range – pattern present > [time1] and < [time2]

The time settings are adjustable from 20 ns to 160 ms ( $\pm 3\%$   $\pm 2$  ns). The time filter recovery time is  $\leq 12$  ns. In the "pattern present < [time]" mode, the pattern must be present  $> 1.5$  ns for the trigger to respond.

**Glitch Trigger:** Use "pattern present < [time]" with [time] selected such that it is just less than the pulse width of the signal you are analyzing. The minimum glitch width is 1.5 ns.

**State Trigger:** A pattern is specified on any three of the four inputs, with the fourth input used as a clock. A trigger will occur on the rising or falling edge of the input specified as the clock when the pattern is present or not present. Setup time for the pattern with respect to the clock is less than or equal to 10 ns; hold time is zero.

## **Delayed Trigger**

**Event-delayed Mode:** The trigger can be qualified by an edge, pattern, time qualified pattern or state. The delay can be specified as a number of occurrences of a rising or falling edge on any one of the four inputs. After the delay, an occurrence of a rising or falling edge on any one of the four inputs will generate the trigger. The occurrence value of the edge to trigger on is selectable from 1 to 16,000,000. The maximum edge counting rate is 70 MHz.

**Time-delayed Mode:** The trigger can be qualified by an edge, pattern or state. The delay is selectable from 30 ns to 160 ms. After the delay, an occurrence of a rising or falling edge on any one of the four inputs will generate the trigger. The occurrence value of the edge to trigger on is selectable from 1 to 16,000,000. The maximum edge counting rate is 70 MHz.

## **TV Trigger**

**60 Hz / 525 Lines:** Source is selected to be any one of the four inputs. Trigger level is adjustable for the selected source. Polarity is selected for positive or negative synchronizing pulses. A trigger occurs on the selected line and field of a 2/1 interlaced composite video signal. Line numbering is 1 to 263 for field 1 and 1 to 262 for field 2. This TV trigger mode is compatible with broadcast standard M.

**50 Hz / 625 Lines:** Source is selected to be any one of the four inputs. Trigger level is adjustable for the selected source. Polarity is selected for positive or negative synchronizing pulses. A trigger occurs on the selected line and field of a 2/1 interlaced composite video signal. Line numbering is 1 to 313 for field 1 and 314 to 625 for field 2. This TV

trigger mode is compatible with broadcast standards B,C,D,G,H,I,K,K1,L and N.

**User-defined Mode:** Source is selected to be any one of the four inputs. Trigger level is adjustable for the selected source. The trigger is qualified with a high or low pulse that meets a selectable time range. The trigger is an occurrence of a rising or falling edge of the source after the qualifying pulse. The time settings for the qualifier are selectable from 20 ns to 160 ms ( $\pm 3\%$   $\pm 2$  ns). The trigger occurrence value is selectable from 1 to 16,000,000.

**NOTE:** *All TV trigger modes require a clamped video signal for stable triggering. Use the HP 1133A TV pod to provide clamped video output that can be used in conjunction with the HP 54503A's TV triggering capabilities.*

**Trigger Holdoff:** Trigger can be held off by either time or events over the ranges:

- Time: 40 ns - 320 ms
- Events: 2 - 16,000,000

An Event is defined as the specified trigger condition. A separate holdoff setting (time or events) is available for each trigger mode except delayed trigger, which is set to 40 ns.

**Noise Reject Trigger:** Improves triggering on noisy signals by increasing hysteresis.

**Display** **Data Display Resolution:** 451 points horizontally by 256 points vertically.

**Number of Screens:** 1, 2 or 4 screens can be selected. This enables overlapping channels or memories for comparison, or displaying them in up to 4 data display areas.

**Display Modes** **Minimum Persistence:** One waveform data value is displayed in each horizontal position of the display. The waveform is updated as new data is acquired for a particular horizontal position.

**Variable Persistence:** The time that each data point is retained on the display can be varied from 200 ms to 10 seconds, or it can be displayed infinitely long.

**Averaging:** The number of averages (n) can be specified in powers of 2, up to 2048. On each acquisition, 1/n times the new data is added to (n-1)/n of the previous value at each time coordinate. Averaging operates continuously, except for the HP-IB digitize command, for which averaging terminates at the specified number of averages.

**Envelope:** Provides a display of the running maximum and minimum voltage levels at each horizontal position for a repetitive waveform.

**Graticules:** The user may choose full grid, axes, frame, or no graticule.

**Connect-the-dots:** Provides a continuous display, connecting the sample points with straight lines. Connect-the dots is operative for modes in which a single valued waveform can be connected, including average, envelope and minimum persistence modes.

**Scroll Mode:** In the Auto Mode at settings from 200 ms/div to 5 s/div the 54503A automatically selects the scroll mode display. It will also select scroll display in the triggered mode with delay reference ( = left and delay  $\geq 0$ ). Scroll mode updates each data point on the displayed waveform as the data is acquired.

**Delta t /Delta V** **Markers:** Dual voltage markers and dual time markers are available. Voltage markers can be independently assigned to channels, memories, or functions.

**Waveform Math** Two independent functions are provided for waveform math. The operators are +, -,  $\times$ , vs, invert, and only. The vertical channels and the waveform memories can be used as operands for the waveform math. Sensitivity and offset for these functions can be adjusted independently.

**Waveform Save** Four non-volatile waveform memories and two volatile pixel memories are provided. Waveform memories store single-valued waveforms, such as an averaged waveform. If an envelope waveform is stored to a waveform memory, it will automatically be stored with the upper waveform in one waveform memory and the lower waveform in another. Pixel memories store an entire screen of waveform data. They are very useful for storing multiple overlapping waveforms and infinite persistence waveforms.

## Automatic Pulse Parameter Measurements

The 54503A offers 16 automatic pulse parameter measurements from the front panel (shown below) and additional measurements via HP-IB including All, Overshoot and Preshoot. The standard measurements are performed with 10%, 50% and 90% voltage thresholds, as defined by IEEE standard 194-1977, "IEEE Standard Pulse Terms and Definitions."

### Automatic measurements available on the HP 54503A.

Risetime	Pulse Width +	Volts amp	Volts avg	Preshoot
Falltime	Pulse width -	Volts base	Volts max	(HP-IB only)
Frequency	Duty Cycle	Volts top	Volts min	Overshoot
Period	Delay	Volts p-p	Volts RMS	(HP-IB only)

## User-Definable Measurement Thresholds

The HP 54503A allows you to set your own thresholds for automatic measurements. Both the upper and lower thresholds can be set, either in % or Volts, as long as the upper threshold value is always  $\geq$  the lower threshold. The mid threshold is always equal to the mid-value between the upper and lower threshold.

**Continuous Measurements:** Allows automatic measurements to be continuously updated, and most recent measurement results displayed. With continuous measurements off, the voltage and time markers are placed on the waveform to indicate the last measurement is taken.

**Measurement Statistics:** The maximum, minimum and average of continuously updated measurements are calculated and displayed. Any three measurements can be selected for simultaneous display.

**Measurement Limit Test:** Maximum and minimum limits can be set for three of the automatic measurements. These continuously updated measurements are compared to the maximum and minimum limits. If the measurements are found to be outside the defined limits, the acquisition is stopped and the waveform can be stored to a memory or the screen can be sent to a printer. In addition, the HP-IB Service Request line can be set, to flag the controller. Measurement limit test can be set to stop after test limits have exceeded, or to continue testing.

## Setup Aids

**Auto-Scale:** Pressing the Auto-Scale button automatically adjusts the vertical and horizontal deflection factors and the trigger level for a display appropriate to the signals applied to the inputs. The Auto-Scale feature requires a signal with a duty cycle greater than

0.5% and a frequency greater than 50 Hz. Auto-Scale is operative only for relatively stable input signals.

**Save/Recall:** Four front panel setups (1-4) may be saved in non-volatile memory.

**Recall Clear:** Resets the HP 54503A to its factory default settings.

**Recall 0:** If Auto-Scale, ECL or TTL preset, or recall setup are inadvertently selected, recall 0 restores the instrument to its last state prior to selection.

**Show** Displays instrument status, including volts/div, offset, and trigger condition.

**Hardcopy** The CRT display contents, including menus and measurement answers, can be transferred directly to an HP-IB raster graphics printer, including the HP 2225A Thinkjet.

**Full HP-IB Programmability** Instrument settings and operating modes, including automatic measurements, may be remotely programmed via HP-IB (IEEE-488). HP-IB programming complies with IEEE 488.2-1988 "Standard Codes, Formats, Protocols, and Common Commands."

**Data Acquisition and Waveform Transfer Rate:** A 500 point waveform data record can be acquired and transferred to a computer at a rate of approximately 10 times per second, as tested with an HP 9000, Series 200 Controller. The acquired data was type normal, completion criteria 100%, with the oscilloscope at a time/division setting of 5  $\mu$ sec/div.

**Data Transfer Rates:** Approx. 120 kbytes/sec.

**Probe Compensation, AC Calibrator Output:** An approximately 1.5 kHz signal is provided for probe compensation. A probe-to-BNC adapter is used to connect the probe to the rear panel Probe Compensation BNC output. During calibration, this output is used to provide other calibration signals, as described in the Service Manual. This same BNC connector is used for trigger output. The utility menu allows the user to switch the BNC from probe compensation and calibration signals to a trigger output pulse. The leading (rising) edge, with amplitude from approximately -400 mV to 0V (when a terminated in 50  $\Omega$ ), is synchronous with system trigger. The trailing (falling) edge

of this pulse occurs approximately at the end of holdoff. The leading (rising) edge should be used as the edge synchronous with trigger.

**DC Calibrator Output:** this output is used for vertical calibration of the 54503A, as described in the Service Manual.

## Product Support

**Built-in Self Test and Calibration Routines:** Internal self-test capabilities provide a 90% confidence that the instrument is operating properly. External test procedures in the service manual provide 100% confidence. Self-calibration routines, also selected through the front panel "utility" menu, ensure that the instrument is operating with its greatest accuracy and requires no external test equipment.

**Low Cost of Ownership:** The HP 54503A carries a three-year warranty. HP's board exchange program assures economical and timely repair of units, reducing cost-of-ownership.

**Solutions:** HP's System Engineering Organization can help you configure an HP-IB system and provide software support for your application. Contact your Hewlett-Packard sales and service office for more information.

---

## General Characteristics

### Environmental Conditions

#### Temperature

**Operating:** 0°C to + 55°C

**Non-operating:** - 40°C to + 70°C

#### Humidity

**Operating:** up to 95% relative humidity (non-condensing) at + 40°C

**Non-operating:** up to 90% relative humidity at + 65°C.

#### Altitude

**Operating:** up to 4 600 meters (15 000 ft)

**Non-operating:** up to 15 300 meters (50 000 ft).

#### Vibration

**Operating:** Random vibration 5-500 Hz, 10 minutes per axis, 0.3 G<sub>rms</sub>

**Non-operating:** Random vibration 5-500 Hz, 10 minute per axis, 2.41

G<sub>rms</sub>; Resonant search 5 to 500 Hz swept sine, 1 Octave/minute sweep rate, (0.75G), 5 minute resonant dwell @ 4 resonances per axis.

**Power Requirements** Voltage: 115/230 V ac, -25% to +15%, 48-66 Hz.  
Power: 350 VA maximum.

**Weight** Net: approximately 10 kg (22 lb).  
Shipping: approximately 20 kg (44 lb).

**Dimensions** Refer to outline drawings below.

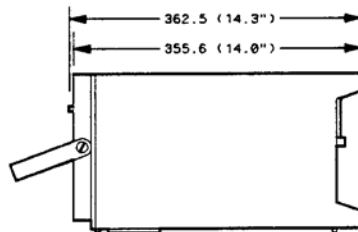
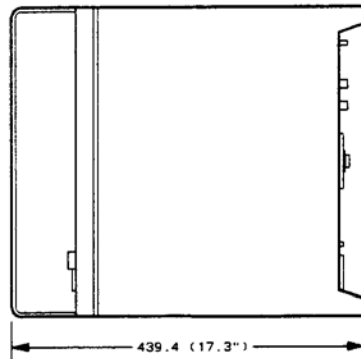

04501E13

NOTES

1. Dimensions are for general information only. If dimensions are required for building special enclosures, contact your HP field engineer.
2. Dimension are in millimetres and (inches).

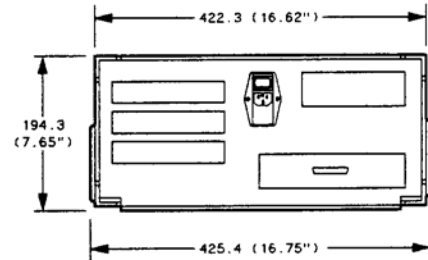

**Index**

# Index

---

## !

Dt/DV markers, 3-5  
n s to complete, 4-2  
+ width, 1-4  
- width, 1-4

## A

abort Key, 12-6, 12-8, 12-10  
acquisition test, 12-5  
add to memory Key, 10-3  
addressed, 12-2  
addressed menu, 12-2  
after save Key, 11-8  
Air Flow Requirements, 2-7  
Algorithms, 1-1  
Altitude, 2-2  
attenuation menu, 12-7  
auto triggered scroll, 4-2  
Automatic measurements, 1-1  
Automatic Top-Base, 1-2  
AUTOSCALE Key, 3-5  
axes, 7-5

## C

cal select Key, 12-9  
Calibration Procedure, 12-12

calibrator protection, 2-3  
chan/mem Key, 9-3  
Channel, 3-7  
CHANNEL Key, 5-1, 12-8, 12-10  
Channel Menu, 5-1  
CLEAR DISPLAY Key, 3-3  
CLEAR key, 3-9  
clear memory Key, 10-3  
clicker Key, 12-11  
clock Key, 6-15  
CLR MEAS key, 11-2  
connect dots Key, 7-6  
connect the dots, 3-5  
Contents of Shipment, 2-1  
continue Key, 12-8, 12-10  
continuous Key, 11-3  
coupling Key, 5-2

## D

D[delta]t markers, 8-3  
data acquisition, 3-3  
default conditions, 3-11  
Define Measure Menu, 11-1  
delay Key, 4-2, 6-22  
Delay Trigger Exercise, 6-23  
Delay Trigger Mode, 6-20  
delayed sweep, 4-3  
Display, 3-7  
display Key, 9-2, 10-2 / 10-3  
Display Menu, 7-1  
Display Mode Key, 7-2  
duty cycle, 1-5

## E

- ECL Key, 5-4
- ECL/TTL presets, 3-5
- Edge Definition, 1-3
- Edge Trigger Exercise, 6-4
- edge Trigger Mode, 6-2
- Entry, 3-8
- EOI Key, 12-3
- Exercise
  - Waveform Save, 10-4
  - Delay Trigger, 6-23
  - Edge Trigger, 6-4
  - Pattern Trigger, 6-10
  - State Trigger, 6-16
  - tv Trigger, 6-29
- Exercise, Waveform Math, 9-7
- exit menu Key, 12-3, 12-6, 12-8, 12-10
- External Equipment
  - Connecting, 2-7

## F

- fail if , 11-8
- falltime, 1-5
- falltime measurements, 1-1
- field Key, 6-28
- FINE Key, 4-1
- firmware revision, 12-1
- form feed Key, 12-3
- frame, 7-5
- frequency, 1-5
- Front Panel Overview, 3-1
- function display, 3-10
- Function Key, 9-2
- fuse module, 2-4

## G

- Gain cal, 12-9
- grid, 7-5

## H

- HARDCOPY Key, 3-3
- holdoff, 3-5
- holdoff Key, 6-3, 6-10, 6-16, 6-28
- HP-IB interface, 3-3
- HP-IB menu, 12-2
- Humidity, 2-2

## I

- Input, 3-9
- Instrument Reset, 3-11
- Intensity Control, 2-7

## K

- key
  - CLR MEAS, 11-2
  - continuous, 11-3
  - EOI, 12-3
  - form feed, 12-3
  - or if, 11-8
  - Run/Stop, 3-2
  - save after, 11-8
  - save to, 11-8
  - standard/user defined, 11-4
  - abort, 12-8, 12-10
  - add to memory, 10-3

AUTOSCALE, 3-5  
cal select, 12-9  
chan/mem, 9-3  
Channel, 5-2, 12-10  
Clear Display, 3-3  
clear memory, 10-3  
clock, 6-15  
connect dots, 7-6  
continue, 12-8, 12-10  
coupling, 5-2  
Delay, 4-2, 6-22  
display, 10-2 / 10-3  
Display Mode, 7-2  
ECL, 5-4  
exit menu, 12-3, 12-6, 12-8, 12-10  
fail if, 11-8  
field, 6-28  
FINE, 3-9  
Function, 9-2  
Hardcopy, 3-3  
holdoff, 6-3, 6-10, 6-16, 6-28  
level, 6-3  
level/polarity, 6-28  
line, 6-28  
Local, 3-3  
meas/meas def/meas limit, 11-3  
more, 5-3  
nonvolatile, 10-2  
#, 7-4  
off/frame/axes/grid, 7-5  
offset, 5-2, 9-4  
operand, 9-3  
operator, 9-3  
paper length, 12-3  
pattern, 6-9  
position, 4-4  
present, 6-16  
probe, 5-3  
qualify on, 6-20  
RECALL, 3-5  
reference, 4-3  
SAVE, 3-6

sensitivity, 9-4  
set, 11-8  
SHOW, 3-6  
single, 3-3  
slope, 6-3  
source, 6-3, 6-27, 10-2  
start cal, 12-8, 12-10  
start test, 12-6  
statistics, 11-3  
store, 10-2  
test, 11-7  
thresholds/measurements, 11-4  
Time/Div, 4-1  
timebase, 4-4  
trigger on, 6-23  
TTL, 5-4  
Vertical Sensitivity, 5-2  
volatile, 10-3  
waveform/pixel, 10-1  
when, 6-9, 6-15  
window, 4-3  
Key-down power up, 3-11  
knob, 3-8 / 3-9

## L

level Key, 6-3  
level/polarity Key, 6-28  
line Key, 6-28  
Line Switch, 2-7  
line voltage selector, 2-4  
List of Accessories, 2-2  
LOCAL Key, 3-3  
loop Test, 12-6

## M

Making Measurements, 1-1  
Maximum Vertical Sensitivity, 1-1  
meas Sub-menu, 11-3  
meas/meas def/meas limit Key, 11-3  
Measure Define, 11-4  
Measure Limit, 11-7  
measurement limit test, 3-5  
Measurement Selection, 11-2  
Measurement Setup, 1-1  
Memory 0, 3-5  
menu  
    channel, 5-1  
Menus, 3-7  
Minimum Vertical Sensitivity, 1-1  
more Key, 5-3

## N

n s to initialize, 4-2  
noise reject Key, 6-3  
nonvolatile Key, 10-2  
nonvolatile memory, 10-2  
#  
    of screens Key, 7-4  
numeric keypad, 3-8

## O

offset Key, 5-2, 9-4  
Offset, hysteresis, trigger cal, 12-9  
1  
    /delta t, 8-3  
Operating Environment, 2-2

Operator Key, 9-3  
or if Key, 11-8

## P

paper length Key, 12-3  
pattern Key, 6-9  
Pattern Trigger Exercise, 6-10  
pattern Trigger Mode, 6-8  
period, 1-5  
persistence, 3-5  
pixel Menu, 10-3  
position Key, 4-4  
power input, 2-3  
Power Requirements, 2-3  
power switch, 2-3  
present Key, 6-16  
probe attenuation, 5-3  
probe attenuation failure, 12-8  
probe cal menu, 12-7  
probe Key, 5-3

## Q

qualify on Key, 6-20

## R

ram Test, 12-5  
range, 6-10  
Rear Panel Layout, 2-3  
RECALL 0, 3-5  
RECALL CLEAR, 3-5, 3-11  
RECALL Key, 3-5  
reference Key, 4-3  
reference point, 4-2  
Repetitive Bandwidth, 1-1

risetime, 1-5  
risetime measurements, 1-1  
RUN/STOP Key, 3-2 / 3-3

## S

Sample Rate, 1-1  
SAVE Key, 3-6  
save to Key, 11-8  
Self Cal menu, 12-9  
selftest menu, 12-4  
sensitivity Key, 9-4  
service menu, 12-11  
set Key, 11-8  
Setup, 3-4  
Shipping, 2-2  
SHOW Key, 3-6  
SHOW screen, 3-11  
SINGLE Key, 3-3  
slope, 3-5  
slope Key, 6-3  
source Key, 6-3, 6-27, 10-2  
standard + width, 1-4  
standard - width, 1-4  
standard/user defined Key, 11-4  
start cal Key, 12-8, 12-10  
start marker, 8-3  
start test Key, 12-6  
State Trigger Exercise, 6-16  
state Trigger Mode, 6-15  
statistics Key, 11-3  
stop marker, 8-3  
Stopped mode, 3-3  
Storage, 2-2  
store Key, 10-2  
submenu  
    attenuation, 12-8  
    time null, 12-9  
Sweep speed, 3-5, 4-1  
System Control, 3-2

## T

talk only, 12-2  
talk only menu, 12-2  
Test  
    loop, 12-6  
test Key, 11-7  
threshold, 6-1  
thresholds/measurements Key, 11-4  
time Key, 12-9  
time null submenu, 12-9  
Time/Div Key, 4-1  
Timebase, 3-7  
timebase Key, 4-4  
Timebase Menu, 4-1  
timebase window, 3-5, 9-3  
Trig'd/auto Key, 6-3  
Trigger, 3-7  
    delay, 6-1, 6-20  
    edge, 6-1 / 6-2  
    pattern, 6-1, 6-8  
    state, 6-1, 6-15  
    tv, 6-1, 6-27  
Trigger level, 3-5, 6-1  
Trigger Menu, 6-1  
trigger on Key, 6-23  
triggered scroll, 4-2  
TTL Key, 5-4  
tv Trigger Exercise, 6-29  
tv Trigger Mode, 6-27

## U

Unpacking, 2-1  
user-defined + width, 1-4  
Utilities, 3-7  
Utility Menu, 12-1

## V

- Vamp, 1-5
- Vavg, 1-6
- Vbase, 1-5
- Vertical offset, 3-5
- vertical position, 5-2
- Vertical Resolution, 1-1
- Vertical sensitivity, 3-5
- Vertical Sensitivity Key, 5-2
- Vmarker 1, 8-2
- Vmarker 2, 8-2
- Vmax, 1-5
- Vmin, 1-5
- volatile Key, 10-3
- voltage selector module, 2-3
- Vp-p, 1-5
- Vrms, 1-6
- Vtop, 1-5

## W

- waveform math, 3-5, 3-7
- Waveform Math Exercise, 9-7
- Waveform Math Menu, 9-1
- waveform Menu, 10-2
- Waveform Save, 3-7
- Waveform Save Exercise, 10-4
- Waveform Save Menu, 10-1
- waveform/pixel Key, 10-1
- when entered, 6-9
- when exited, 6-9
- when Key, 6-9, 6-15
- when present, 6-10
- window Key, 4-3
- Window position, 4-4
- Window timebase, 4-4